

Congratulations!

You have purchased one of the many quality items offered by Auto Ventshade. We take the utmost pride in our products and want you to enjoy years of satisfaction from your investment. We have made every effort to ensure that your product is top quality in terms of fit, durability, finish and ease of installation.

Consumer Note:

Auto Ventshade branded Chrome Hood Shield products have been manufactured with a high quality chrome finish. Due to the chroming process some small unfinished areas remain on the mounting area of the shield. These non-chromed areas should not peel or flake at any of these locations. Each Chrome Hood Shield is inspected prior to packaging to ensure that Lund International's surface quality standards have been met. You should see an inspection tag on each Chrome Hood Shield. We want you to be completely satisfied with this product. If you have a problem please contact Customer Relations at 800-241-7219.



AUTO VENTSHADE™
 Lund International, Ventshade Accessories Division
 655 Raco Drive, Lawrenceville, GA 30045
 800-241-7219 • Fax 770-339-5839 • Visit us at lundinternational.com

© 2004 Lund International, Inc. All rights reserved.
 Auto Ventshade™, the Auto Ventshade™ logo and the AVS™ logo are trademarks of Lund International, Inc.

AVS
AUTO VENTSHADE™
Chrome Hood Shield

Contents **NOTE:** Actual product may vary from illustration.

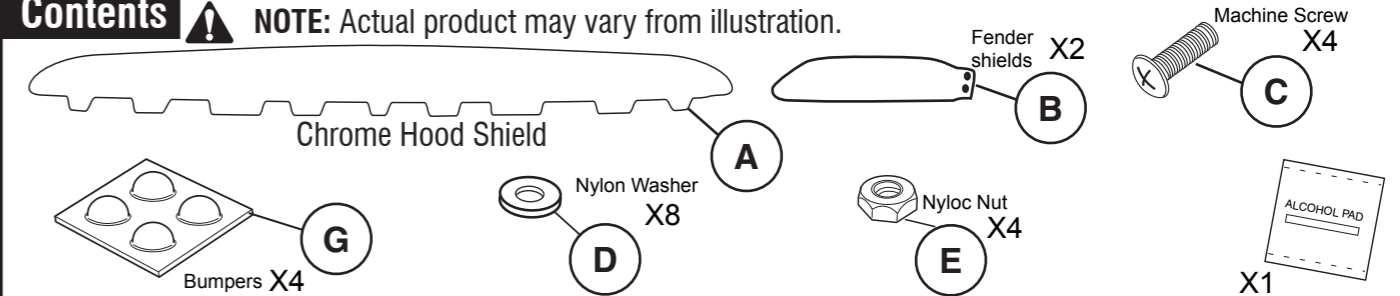

Tools Required



Car Wash Supplies Clean Towel Appropriate hand tools for attaching shield to hood.

Important **WARNING/CAUTION/NOTE**

Please read this manual and follow instructions carefully. To emphasize special information, the symbol and the words **WARNING**, **CAUTION** and **NOTE** have special meanings. These special meanings apply except when laws or regulations require that the signal words be used with a different meaning.

Preparation Before Painting / Installation

A trial fit is recommended to ensure proper positioning and fit, since installing and then removing the Bugflector will significantly degrade the adhesive performance of the tape. Please check fit of parts before painting as we will not accept the return of modified or painted parts, nor assume any responsibility for parts painted in error. Wash your vehicle's hood to remove any debris and/or dirt. Dry the hood with a clean towel.

Care and Cleaning

1. Avoid the use of automatic "brush-style" car washes.
2. Do not use cleaning solvents of any kind.
3. Wash only with mild soap & dry with a clean cloth.



AUTO VENTSHADE™
 Lund International, Ventshade Accessories Division
 655 Raco Drive, Lawrenceville, GA 30045
 800-241-7219 • Fax 770-339-5839 • Visit us at lundinternational.com

© 2004 Lund International, Inc. All rights reserved.
 Auto Ventshade™, the Auto Ventshade™ logo and the AVS™ logo are trademarks of Lund International, Inc.

Installation Steps

NOTE: Actual application may vary slightly from illustrations.

CS06

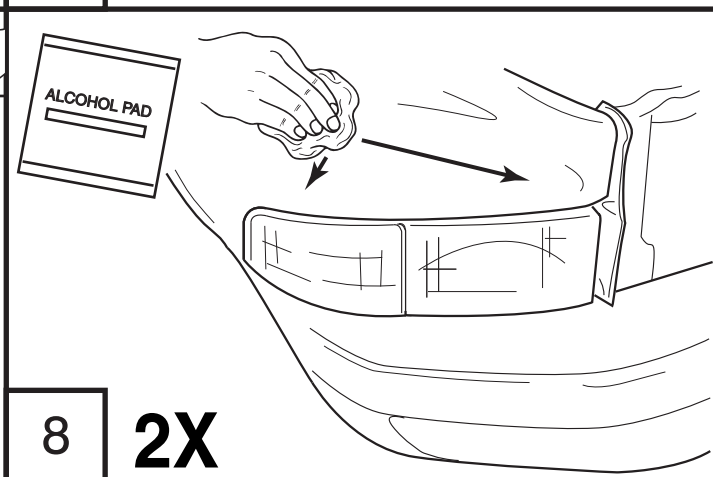
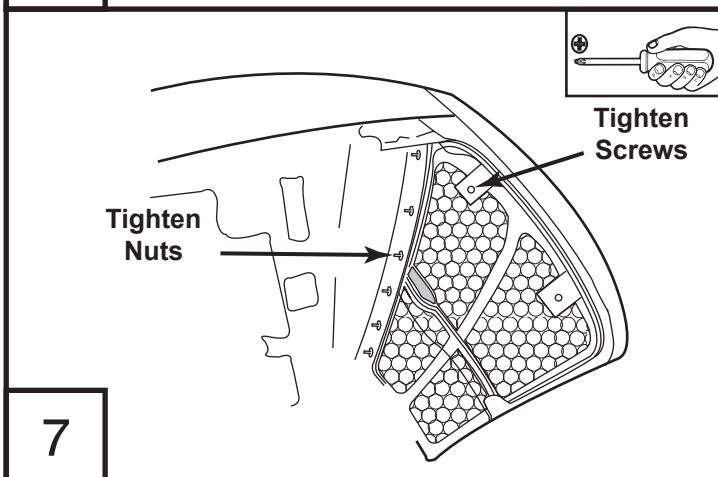
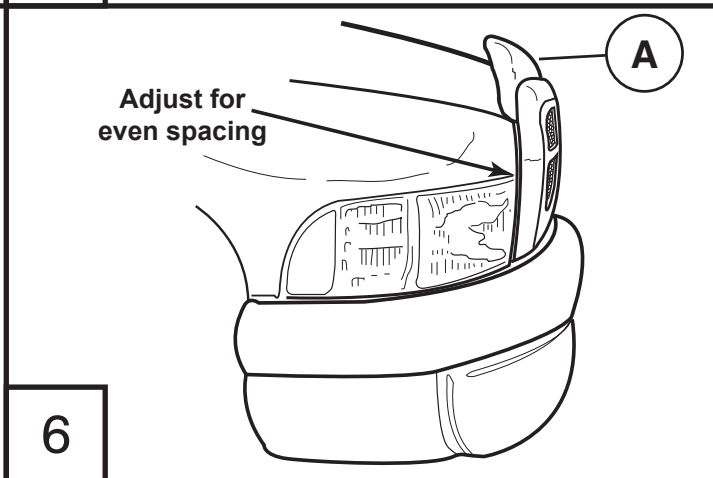
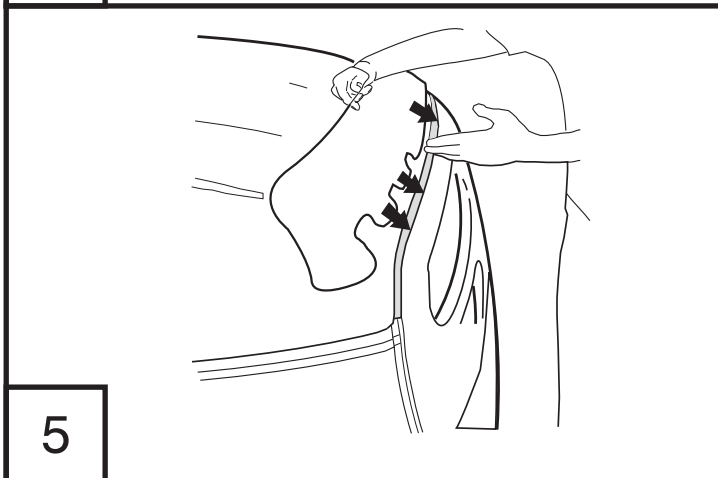
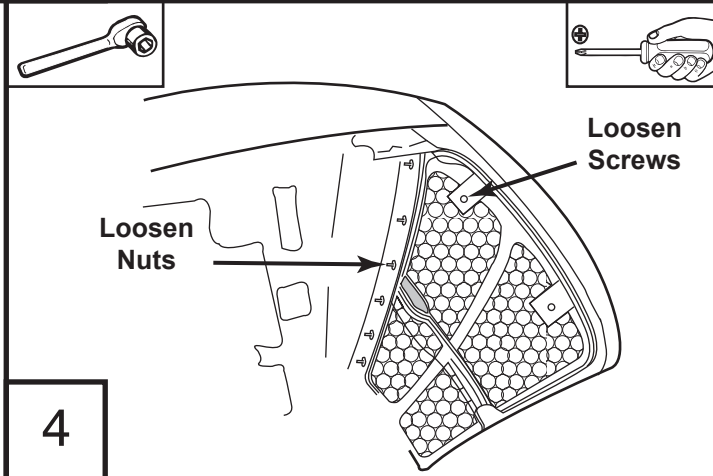
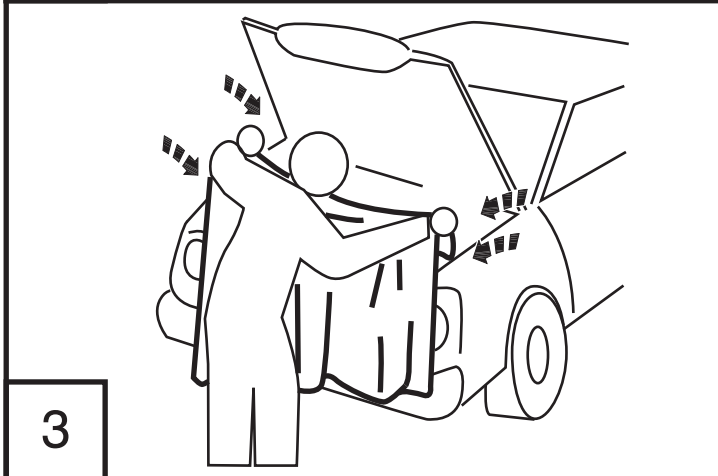
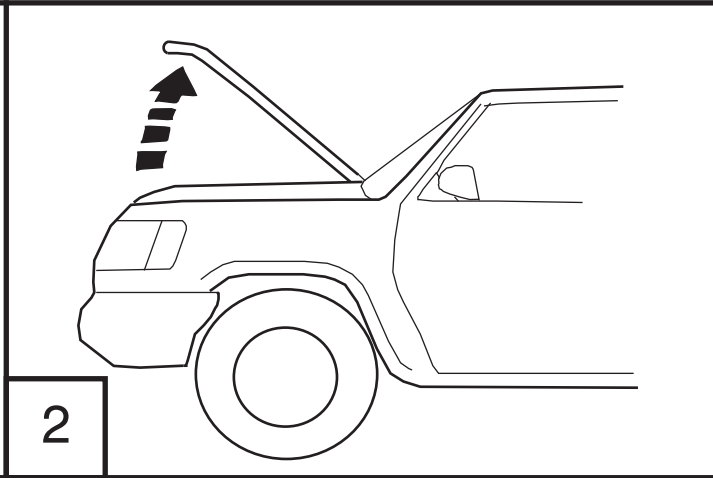
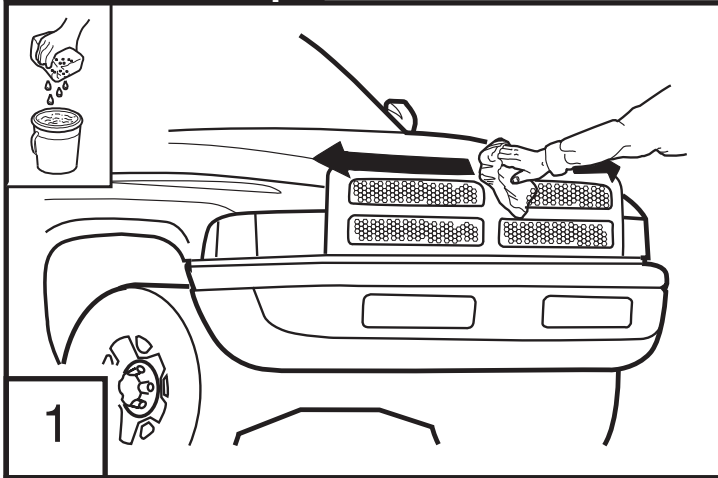

Installation Steps

NOTE: Actual application may vary slightly from illustrations.

CS06

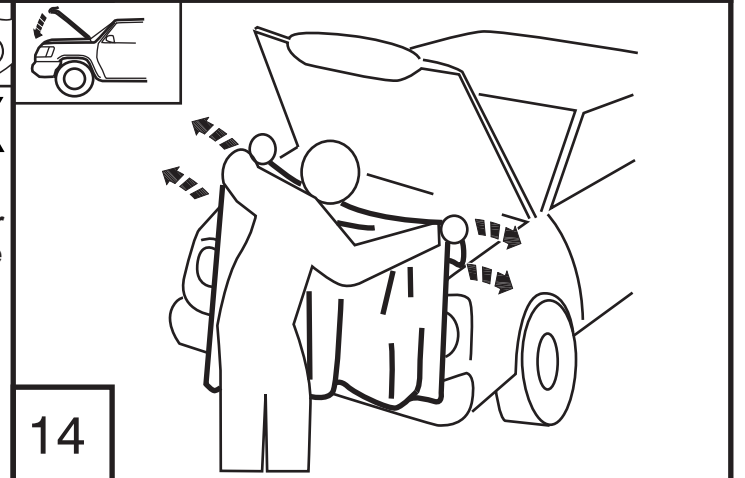
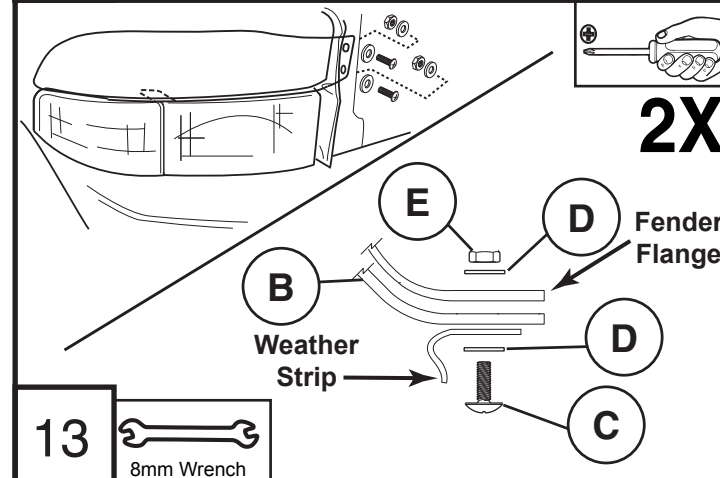
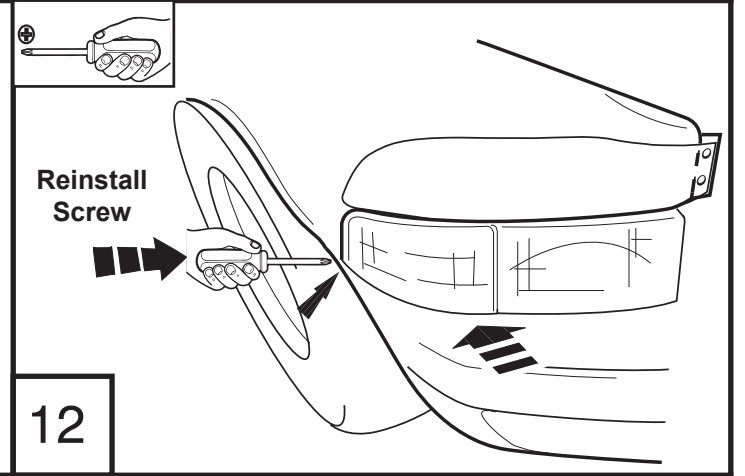
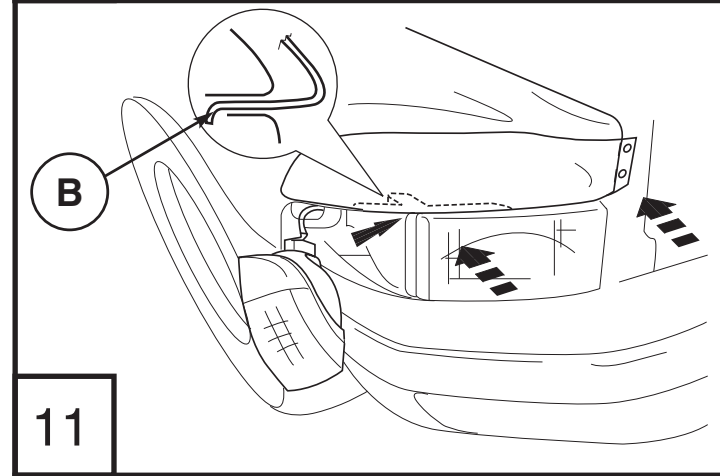
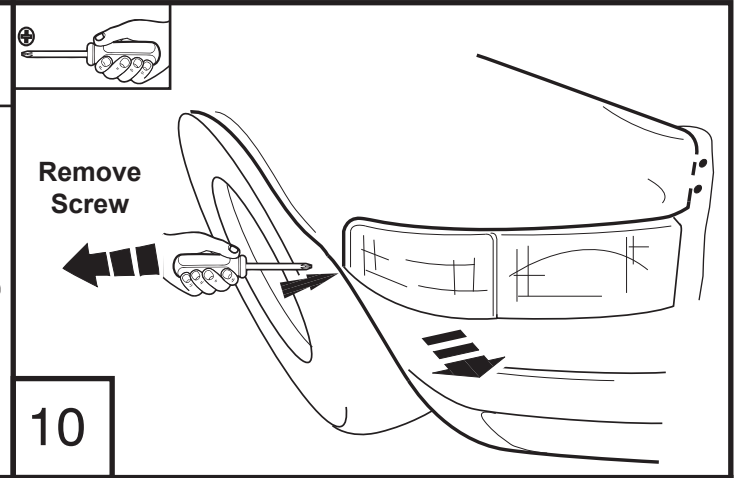
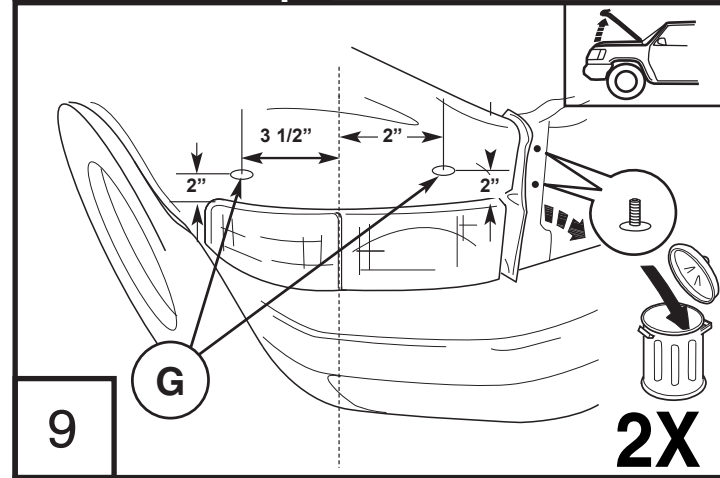

Felicidades

Usted ha comprado uno de los tantos artículos de calidad de Auto Ventshade. Nuestros productos son nuestro mayor orgullo. Deseamos que disfrute de años de satisfacción con su inversión. Hemos realizado todos los esfuerzos para asegurarnos de que su producto sea de la mejor calidad en cuanto a ajuste, durabilidad, acabado y facilidad de instalación.

Nota Del Consumidor:

Ventshade auto calificado los productos del protector de la capilla del cromo se ha fabricado con un final del cromo de la alta calidad. debido al proceso que croma sigue habiendo algunas áreas inacabadas pequeñas en el área mounting del protector. Estas áreas no-cromadas no deben pelar o formar escamas en cualesquiera de estas localizaciones.

Cada protector de la capilla del cromo se examina antes del empaquetado para asegurarse de que se han resuelto los estándares de calidad superficial internacionales de Lund. Usted debe ver una etiqueta de la inspección en cada protector de la capilla del cromo.

Quisiéramos que usted fuera satisfecho totalmente con este producto. Si usted hace que un problema por favor entre en contacto con relaciones de cliente en 800-241-7219.



Lund International, Ventshade Accessories Division
655 Raco Drive, Lawrenceville, GA 30045

800-241-7219 • Fax 770-339-5839 • Visite nuestro sitio: lundinternational.com

© 2004 Lund International, Inc. Todos los derechos reservados.

Auto VentshadeTM, el logo de Auto VentshadeTM y el logo de AVSTM son marcas comerciales de Lund International, Inc.



Protector De la Capilla Del Cromo

Contenido

NOTE: El producto real puede variar de la ilustración.

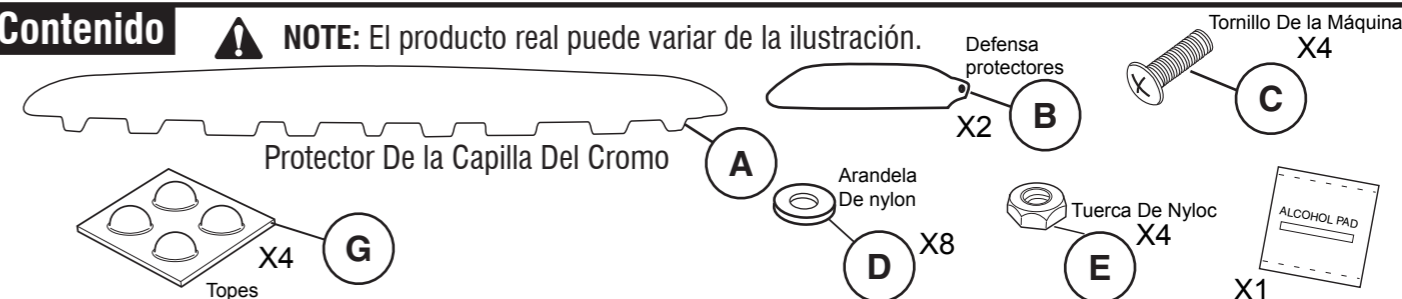

Herramientas necesarias



Importante

ADVERTENCIA / PRECAUCIÓN / AVISO

Lea este manual y siga las instrucciones al pie de la letra. Para destacar la información más importante, el símbolo y las palabras **ADVERTENCIA**, **PRECAUCIÓN** y **AVISO** tienen significados especiales. Estos significados especiales se aplican a menos que existan leyes o reglamentaciones que exijan que se utilicen con un significado particular.

Preparación antes de pintar o instalar

La temperatura ideal para realizar la instalación es entre los 65° y los 110°F (entre 18° y 43°C). Se recomienda realizar un ajuste de prueba para asegurar el posicionamiento y ajuste correcto, ya que instalar o quitar las viseras Ventvisor sucesivamente ocasionará el desgaste de la cinta. Compruebe que las piezas se ajusten correctamente antes de pintarlas, ya que no aceptaremos la devolución de piezas modificadas o pintadas, ni nos haremos responsables por piezas que se hayan pintado por error.

Cuidado y limpieza

1. Evite utilizar los servicios automáticos de limpieza de vehículos que utilizan cepillos.
2. No utilice limpiadores al solvente de ningún tipo.
3. Limpie solamente con agua jabonosa y seque con un paño limpio.



Lund International, Ventshade Accessories Division
655 Raco Drive, Lawrenceville, GA 30045

800-241-7219 • Fax 770-339-5839 • Visite nuestro sitio: lundinternational.com

© 2004 Lund International, Inc. Todos los derechos reservados.

Auto VentshadeTM, el logo de Auto VentshadeTM y el logo de AVSTM son marcas comerciales de Lund International, Inc.

Pasos De la Instalación

NOTE: El uso real puede variar levemente de ilustraciones.

CS06

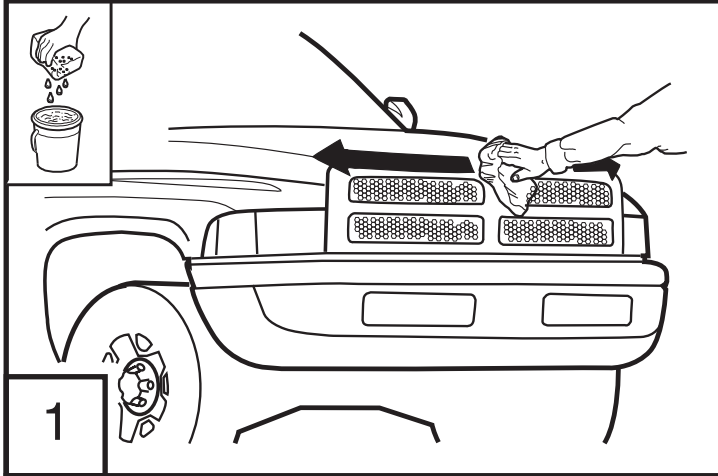

1

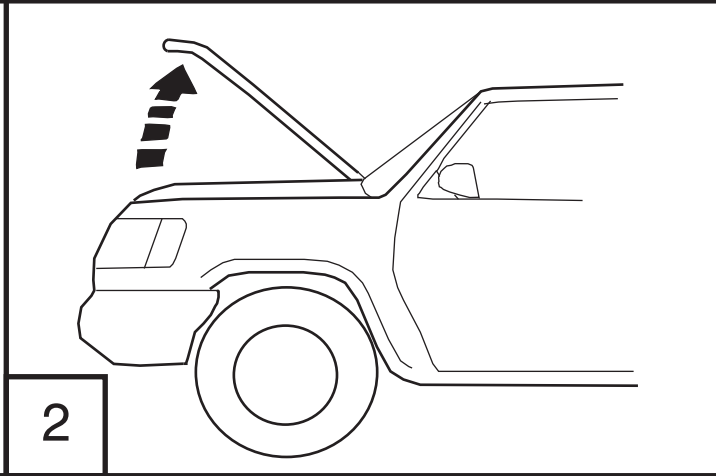

2

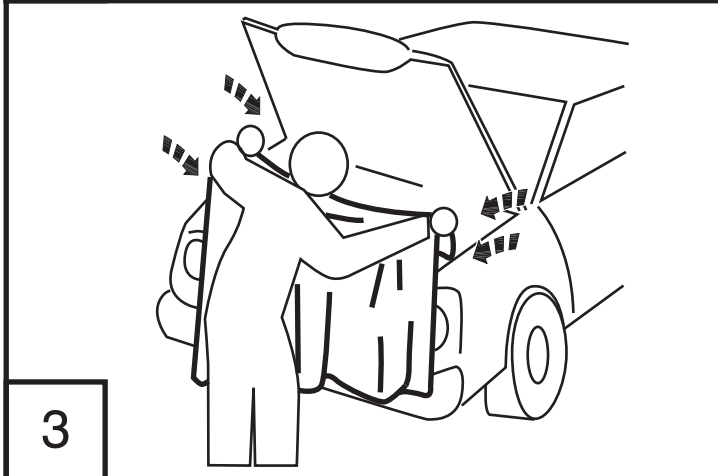

3

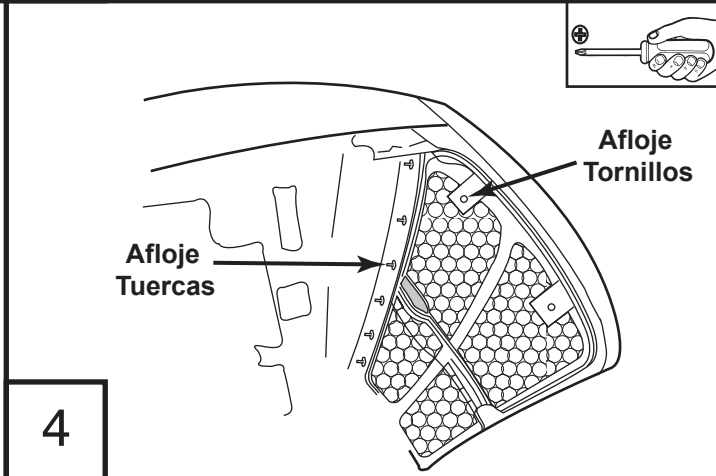

4

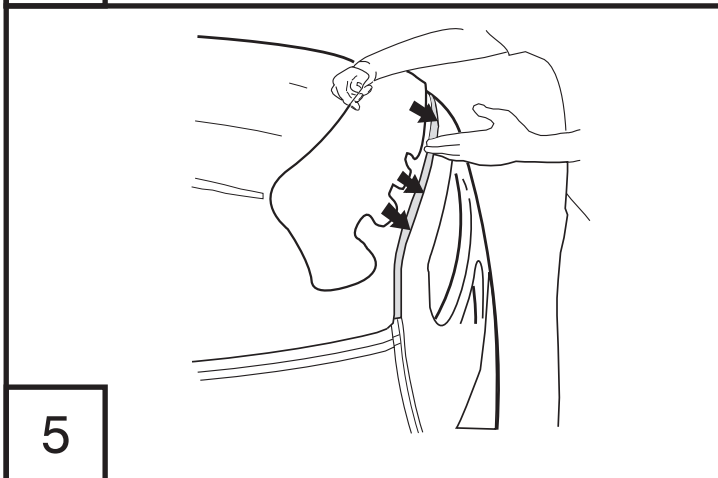

5



6

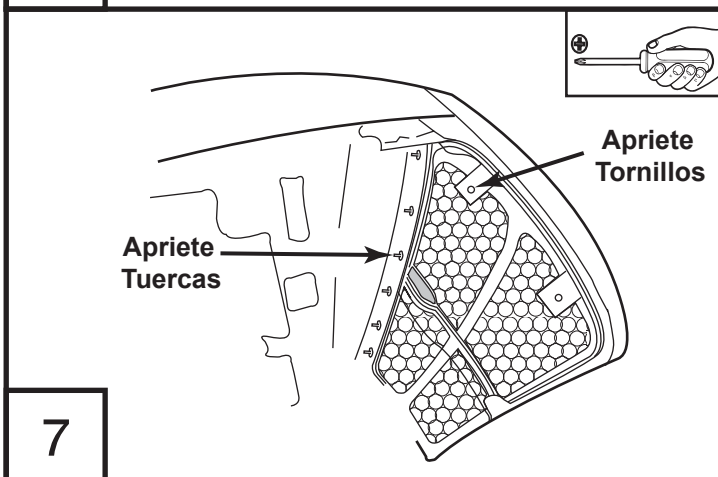

7

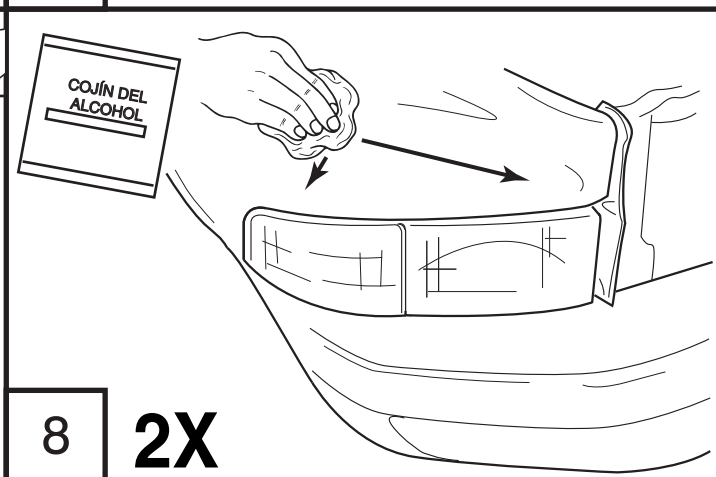

8

2X

Pasos De la Instalación

NOTE: El uso real puede variar levemente de ilustraciones.

CS06

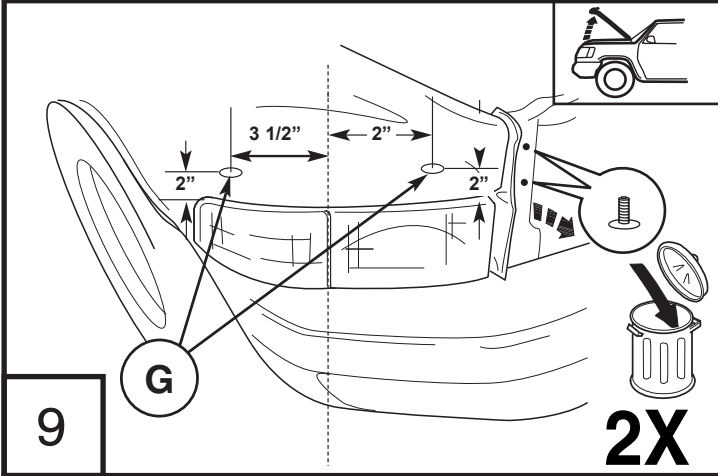

9

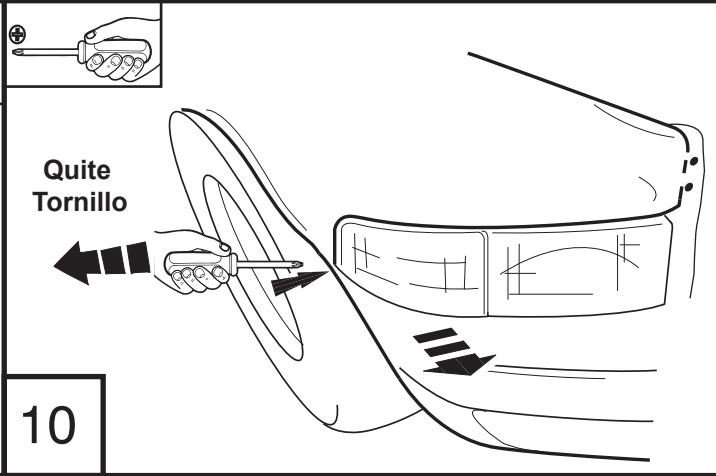

10

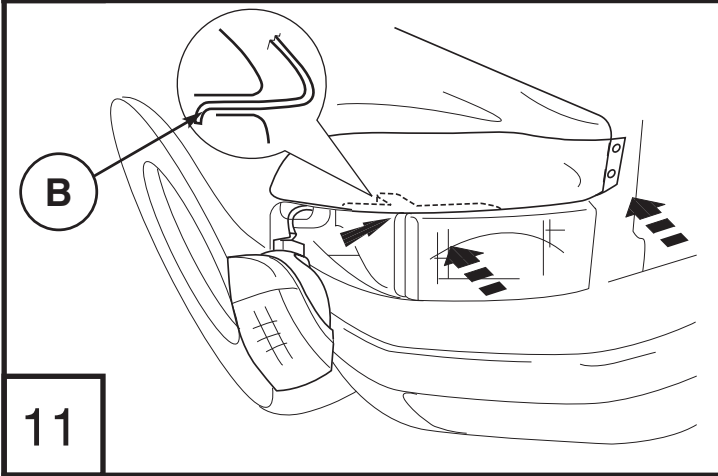

11

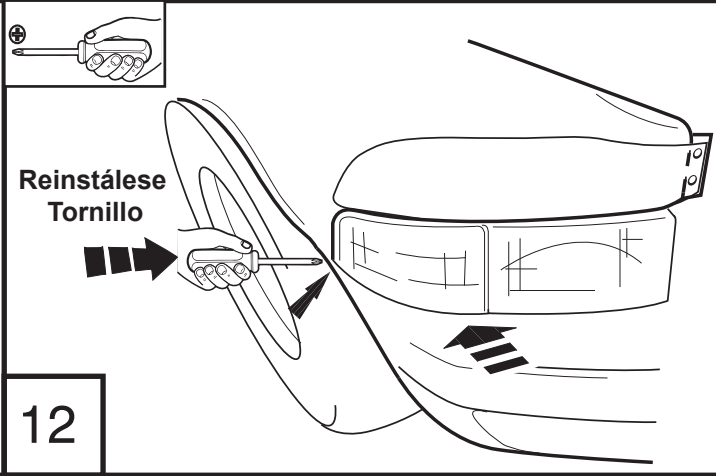

12

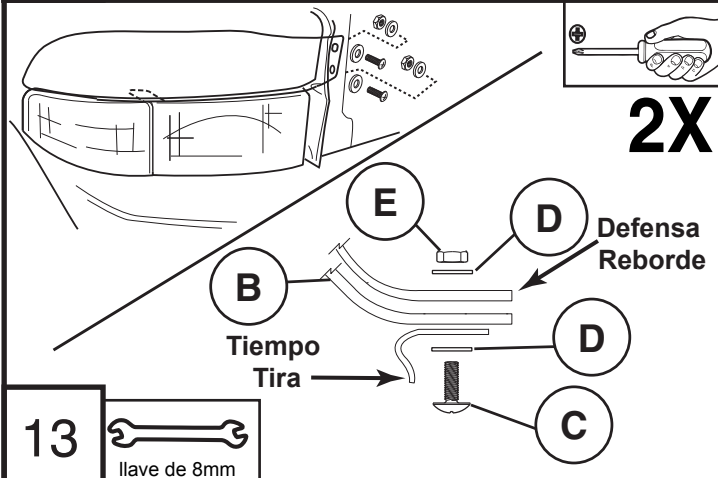

13

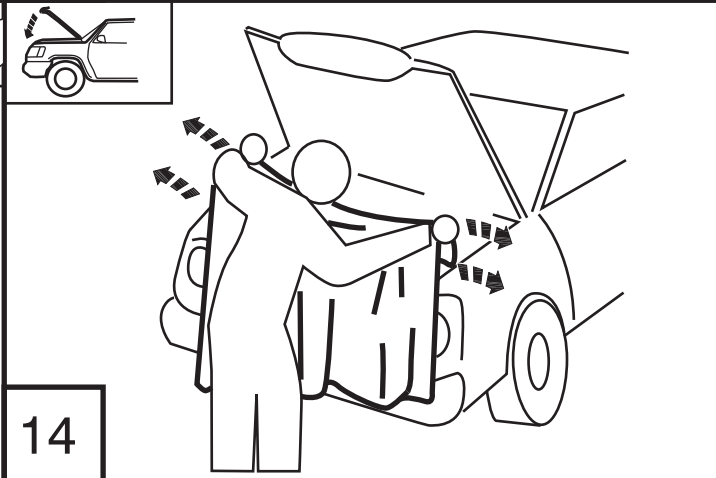

14

Félicitations !

Vous avez acheté l'un des nombreux produits de qualité fabriqués par Auto Ventshade. Nous sommes extrêmement fiers de nos produits et souhaitons que vous tiriez des années de satisfaction de votre investissement. Nous avons pris toutes les mesures nécessaires pour assurer que ce produit est d'une qualité supérieure en ce qui concerne l'ajustement, la durabilité, la finition et la facilité d'installation.

Note Du Consommateur :

Ventshade automatique marqué des produits de bouclier de capot de chrome ont été fabriqués avec une finition de chrome de haute qualité. En raison du processus passant au bichromate de potasse quelques petits secteurs non finis demeurent sur le secteur mounting du bouclier. Ces secteurs non-passés au bichromate de potasse ne devraient éplucher ou s'écailler à aucun de ces endroits.

Chaque bouclier de capot de chrome est inspecté avant d'emballer pour s'assurer que des standards de qualité extérieure internationaux de Lund ont été rencontrés. Vous devriez voir une étiquette d'inspection sur chaque bouclier de capot de chrome. Nous voulons que vous soyez complètement satisfait de ce produit. Si vous faites entrer en contact avec un problème svp des relations de client à 800-241-7219.



Lund International, Ventshade Accessories Division
655 Raco Drive, Lawrenceville, GA 30045
800-241-7219 • Fax 770-339-5839 • Visitez notre site lundinternational.com

© 2004 Lund International, Inc. All rights reserved.
Auto Ventshade™, le Auto Ventshade™ logo and the AVS™ sont des marques de commerce de Lund International, Inc.

**Bouclier De Capot De Chrome****Contenu**

NOTE: Le produit réel peut changer de l'illustration.

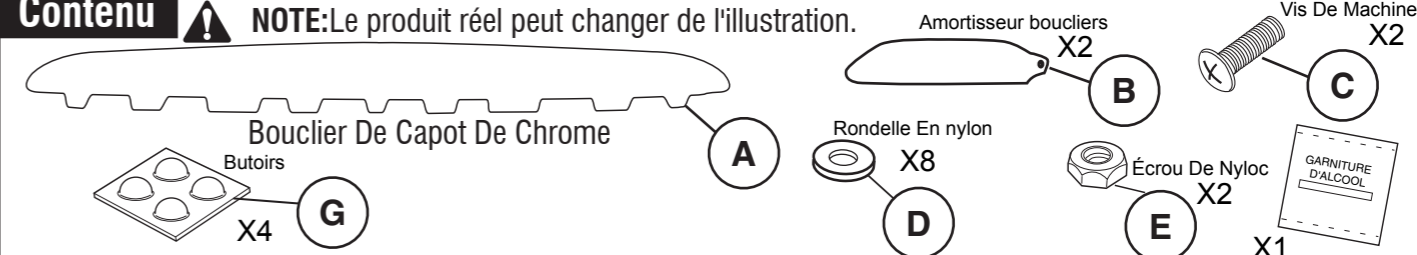
**Outils nécessaires**

Serviette Propre
Approvisionnement De Lavage De Voiture

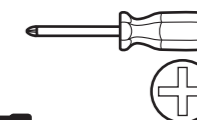

clé de 8mm

Les outils à main appropriés pour le déplacement du grill ont attaché au capot.

Important**AVERTISSEMENT/ATTENTION/REMARQUE**

Lire ce manuel et suivre les instructions attentivement. Les symboles et termes **AVERTISSEMENT**, **ATTENTION** et **REMARQUE** sont destinés à attirer l'attention et ont chacun une signification particulière. Ces significations sont valables, sauf lorsque les lois ou réglementations exigent que ces termes soient interprétés différemment.

Entretien et nettoyage.

La température idéale pour l'installation est de 18 à 43 °C (65 à 110 °F). Il est recommandé de procéder à un essai pour vérifier le placement, étant donné que l'installation et le retrait du Ventvisor cause une réduction du pouvoir adhésif de la bande. Vérifier l'ajustement des pièces avant peinture, car nous n'acceptons pas le retour de pièces modifiées ou peintes et déclinons toute responsabilité en ce qui concerne les erreurs de peinture.

Entretien et nettoyage.

1. Éviter d'utiliser les stations de lavage équipées d'un système "à brosse".
2. Ne pas utiliser de solvants.
3. Laver exclusivement avec de l'eau savonneuse et sécher avec un chiffon propre.



Lund International, Ventshade Accessories Division
655 Raco Drive, Lawrenceville, GA 30045
800-241-7219 • Fax 770-339-5839 • Visitez notre site lundinternational.com

© 2004 Lund International, Inc. All rights reserved.
Auto Ventshade™, le Auto Ventshade™ logo and the AVS™ sont des marques de commerce de Lund International, Inc.

