



Wire Harness Installation Instructions

For Installing:

**Part #20122
14 Circuit
1969 – 1970 Ford Mustang**

Manual #90557



Perfect Performance Products, LLC

Painless Performance Products Division

2501 Ludelle Street

Fort Worth, TX 76105-1036

800-423-9696 phone – 817-244-4024 fax

Web Site: www.painlessperformance.com

E-Mail: painless@painlessperformance.com

If you have any questions concerning the installation of this harness or having trouble in general, feel free to call Painless Performance Products' tech line at 1-800-423-9696. Calls are answered from 8am to 5pm central time, Monday thru Friday, except holidays.

We have attempted to provide you with as accurate instructions as possible, and are always concerned about corrections or improvements that can be made. If you have found any errors or omissions, or if you simply have comments or suggestions concerning these instructions, please write us at the address on the cover and let us know about them. Or, better yet, send us a fax at (817) 244-4024 or e-mail us at painless@painlessperformance.com. We sincerely appreciate your business.

Perfect Performance Products, LLC shall in no event be liable in contract or tort (including negligence) for special, indirect, incidental, or consequential damages, such as but not limited to, loss of property damage, or any other damages, costs or expenses which might be claimed as the result of the use or failure of the goods sold hereby, except only the cost of repair or replacement.

P/N 90557 Painless Wiring Manual

Jan. 10, 2007

Copyright © 2007 by Perfect Performance Products, LLC

TABLE OF CONTENTS

1.0	Introduction	
2.0	About These Instructions.....	4
3.0	Contents in The Painless Wire Harness Kit.....	5
4.0	Tools Needed.....	5
5.0	Pre-Installation and Harness Routing Guidelines.....	6
6.0	Harness Installation Instructions.....	6
6.1	General Installation	
6.2	Harness Attachment	
6.3	Grounding The Automobile	
6.4	Terminal Installation and Making Connections	
6.5	Testing The System	
7.0	Specific Circuit Connections.....	14
7.1	Alternator/Regulator/Solenoid	
7.2	High Amperage Alternator Kit	
7.3	Engine Section	
7.4	Headlight Section	
7.5	Rear Light Section	
7.6	Interior Lighting	
7.7	Dimmer Switch	
7.8	Headlight Switch	
7.9	Turn Signal Switch and Brake Light Switch	
7.10	Gauge Cluster Section	
7.11	Ignition Switch	
7.12	Wiper Switch/ Wiper Motor	
7.13	Interior Ground	
7.14	Console	
7.15	Heater-A/C Components	
7.16	Radio	
7.17	Glove Compartment	
7.18	Accessory Relay	
8.0	Wire Connection Index and Fuse Requirements.....	33

LIST OF TABLES

Table 8.1	Fuse Requirements.....	34
Table 8.2	Wire Connection Index (1 of 6).....	34
Table 8.2	Wire Connection Index (2 of 6).....	35
Table 8.2	Wire Connection Index (3 of 6).....	36
Table 8.2	Wire Connection Index (4 of 6).....	37
Table 8.2	Wire Connection Index (5 of 6).....	38
Table 8.2	Wire Connection Index (6 of 6).....	39
Table 8.2	Wire Connection Index (6 of 6).....	40

Painless Performance Products recommends you, the consumer, read this installation manual from front to back before installing this harness. Due to the variables in modifications done to these classic 1969 and 1970 Mustangs, reading this manual will give you considerable insight on the proper installation of this harness in an original or modified application.

1.0 INTRODUCTION

You have purchased what we at Painless Performance Products believe to be the most up-to-date and easiest-to-install automotive wire harness on the market. It is designed for easy installation, even if you have no electrical experience

All Kits have a built-in-anti-theft feature. Removing the fuse labeled "coil" from the fuse block will prevent the vehicle from starting.

The proper fuses have been pre-installed in the fuse block. In addition, all wires are color-coded and marked for easy identification. This will help you identify the different circuits during installation and later on if additions to the overall system are necessary. For fuse specifications and wire color designations, see **Section 8.1 and Table 8.1**.

This Painless wire harness is designed to be used in 1969 - 1970 Ford Mustangs. All wire is 600 volt, 257°F, TXL. Standard automotive wire is GPT, 300 volt, 176°F, with PVC insulation.

This complete Classic Mustang wiring system has been designed with four major sections incorporated into it:

ENGINE SECTION: Water temperature, oil pressure, aftermarket tachometer, coil, choke, a/c compressor clutch, coil, wiper motor, ignition bypass (for ballast resistor), reverse switch and neutral safety switch

HEADLIGHT SECTION: Includes high beam, low beam, park lights, marker lights right turn, left turn, horns, voltage regulator, starter solenoid, washer pump, brake warning, battery feed and alternator.

UNDER-DASH and INTERIOR SECTION: Includes wires to connect heater-a/c switch, headlight switch, turn signal switch, radio, tachometer (factory and aftermarket), ignition switch, cigar lighter, dimmer switch, brake switch, a/c blower motor, wiper switch, gauges and indicator lights, right and left door jam switches, shift indicator light, courtesy lights, clock, and glove box.

REAR LIGHT SECTION: Includes dome light, taillights, stoplights, left and right turn signals, marker lights trunk light, backup lights, license plate light, and fuel sending unit.

Note: Be sure to retain Convertible Power Top wiring, Cruise Control wiring, Sport Lamp wiring, and Tilt Wheel wiring when removing the old harness. Circuits for these accessories are NOT included in this harness.

2.0 ABOUT THESE INSTRUCTIONS

The contents of these instructions are divided into major **Sections**, as follows:

- 1.0 Introduction
- 2.0 About These Instructions
- 3.0 Contents of Painless Wire Harness Kit
- 4.0 Tools Needed
- 5.0 Pre-Installation and Harness Routing Guidelines
- 6.0 Harness Installation Instructions
- 7.0 Specific Circuit Connections
- 8.0 Wire Connection Index and Fuse Requirements

Sections are divided into subsections and **Paragraphs**. Throughout these instructions, the **Figure** numbers refer to illustrations and the **Table** numbers refer to information in table form. These are located in Sections or Paragraphs corresponding to the number. Always pay special and careful attention to any *Notes*, especially those in the Tables, and any text marked **Caution**.

3.0 CONTENTS OF THE PAINLESS WIRE HARNESS KIT

Refer to the list below to take inventory of all the parts in the kit. If anything is found to be missing, contact the dealer the kit was purchased from or Painless Performance at (800)423-9696. The 1969/1970 Mustang Wire Harness Kit should contain the following items:

- The Main Wire Harness, with Fuse Block, pre-wired fuses and relays installed.
- Bag Kit: 1 pkg. of small and 1 pkg. of large Nylon Tie Wraps, Ballast Resistor, Maxi Fuse, 2 Firewall Grommets, Aluminum Plate, and a Fuse Identification Label.
- Fuse block base and cover
- Parts Box containing Terminals, Splices, Spare Fuses etc.



Figure 3-1 Painless Wire Harness Kit

4.0 TOOLS NEEDED

In addition to basic hand tools the following will also be needed:

- Crimping Tool *Note: Use a quality tool to avoid over-crimping.*
- Wire Stripper
- Test Light or Volt Meter
- Small (10 amp or less) Battery Charger

5.0 PRE-INSTALLATION AND HARNESS ROUTING GUIDELINES

Installation of this wire harness consists mainly of two parts:

- The physical routing and securing of the wire harness.
- The connection of the individual circuits to their components.

These two major tasks are not separate steps, but are integrated together. In other words, you will route a section of wires and make that sections connections. Route the next section of wires and make those sections connections. The layout of this 1969-1970 Mustang harness will dictate how to physically route the harness in your automobile. The breakouts and connections are very close to the original Ford harnesses and should fit just as well if not better. It's a good idea to document how the original harness was routed as this new one follows most of the same routing. The fitment greatly depends on to what extent you want to secure and conceal the harness. Painless offers some general guidelines and routing practices starting in **Section 5.2**, GENERAL installation instructions in **Section 6.0**, and precise instructions concerning the electrical connections you will make in **Section 7.0**. To help you begin thinking through the installation of your wire harness please read the following sections:

- 5.1** Familiarize yourself with the harness by removing the harness from the box, laying it out on a table or on the floor and locating each of the harness sections. Whenever a particular harness section is referred to in these instructions it is shown in "all caps": ENGINE SECTION.
- 5.2** It is recommended to route the harness through and around open areas inside the car. Inside edges provide protection from hazards and also provide places for tie wraps, clips, and other support.
- 5.3** Route the harness away from sharp edges, exhaust pipes, hood, trunk and door hinges.
- 5.4** Plan where harness supports will be located. Allow enough slack at places where movement could occur (body to frame, frame to engine, etc.)
- 5.5** At wire ends, don't depend on the terminals to support the harness. The weight of the harness could cause terminals to disconnect or copper wire strands to break.
- 5.6** The wires should be bundled into groups. Use nylon ties, poly split loom, or tape.

6.0 HARNESS INSTALLATION INSTRUCTIONS

6.1 General Installation

CAUTION: DISCONNECT THE POWER FROM YOUR VEHICLE BY REMOVING THE NEGATIVE (BLACK) BATTERY CABLE FROM THE BATTERY.

- 6.1.1** Mount the base to the left of the stock fuse block location with two of the self tapping screws from the parts kit. **See Figure 6-1.**
- 6.1.2** Try to position the base over the seam/indention in the fire wall, to the left of the 3 spot welds. This will ensure the screws used to mount the fuse block base will not be visible in the engine compartment. **See Figure 6-2**



Figure 6-1 Fuse Block Base

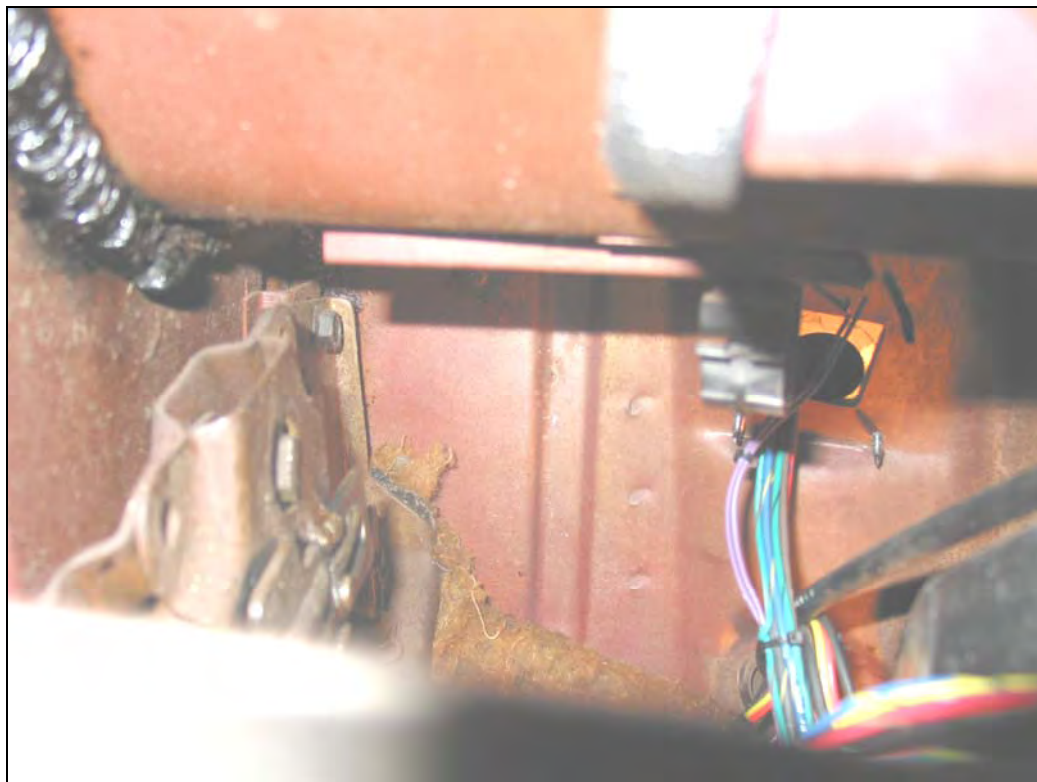

Figure 6-2 Fuse Block Base Location



Figure 6-3 Routing Fuse Block through Instrument Cluster Opening

- 6.1.2** Route the fuse block and attached harness through the instrument cluster opening and snap it into the fuse block base with the relays closest to the windshield. **See Figure 6-3 and Figure 6-4.** (Note: The fuse block does **not** need to be grounded.)

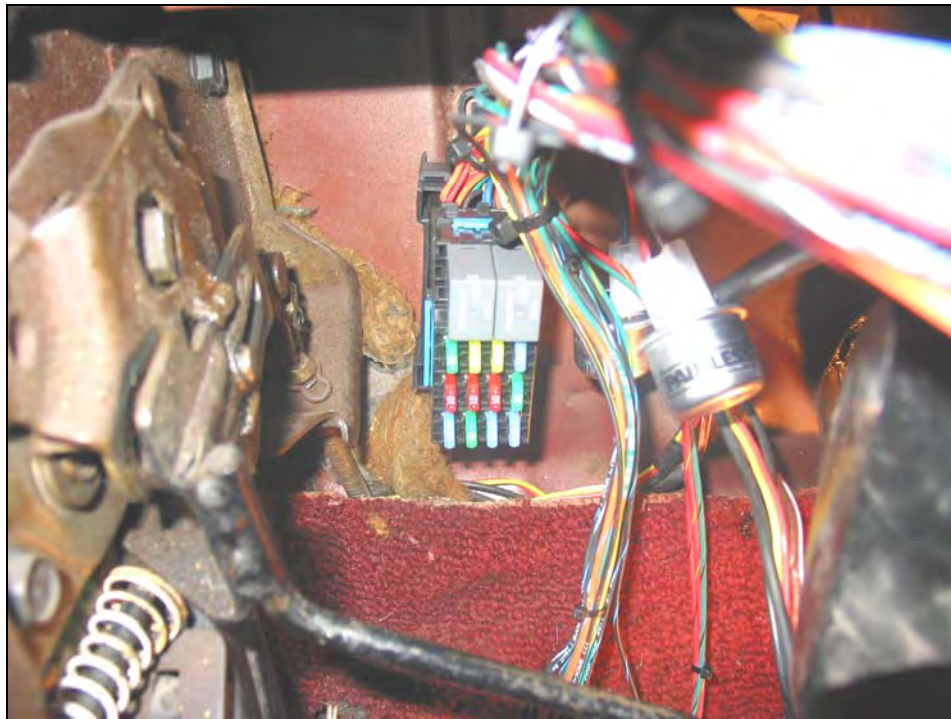

Figure 6-4 Fuse Block Snapped Into Base

- 6.1.3** Pull all the wires located in the HEADLIGHT SECTION and the TAIL SECTION down through the gauge cluster opening. It is easier to pull these wires down than it is to feed all the interior wires up through the opening.

- 6.1.4 Locate the aluminum plate included with the parts kit. This plate is used to cover the factory hole the bulk head connector once used. Install the larger grommet included with this kit into the hole on the plate. With the grommet installed, it is easier to center the plate over the hole left in the fire wall. Using 4 screws included with this kit install the plate over the existing hole in the fire wall. **See Figure 6-5**



Figure 6-5 Firewall Plate

- 6.1.5 Once the plate is installed, remove the grommet. Starting with the Voltage Regulator connector, feed the **HEADLIGHT SECTION** through the plate into the engine compartment. Now with the headlight section pulled through the plate, the grommet will need to be cut to fit around the wires. Split the grommet on one side; *do not cut the grommet in half*. **See Figure 6-6** With the grommet cut, install it around the wire and into the plate. It will be a tight fit.



Figure 6-6 Grommet Split

6.1.6 Route the HEADLIGHT SECTION following the same path the factory harness took. Run the harness long the driver's side inner fender and shock tower, down to the hole at the bottom of the core support, through the core support, and along the bottom of the support over to the passenger side, and feed the Voltage Regulator, Starter Solenoid, and Alternator wires through the bottom of the core support on the passenger side back into the engine compartment. **See Figures 6-7 A,B,C**

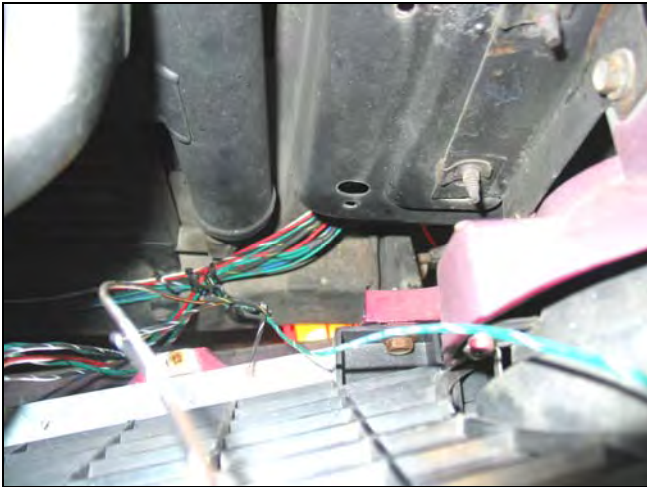

Figure 6-7A Headlight Section Routing



Figure 6-7B Headlight Section Routing



Figure 6-7C Headlight Section Routing

6.1.7 Now locate the **TAIL SECTION**. This section of the harness will be routed down the side of the fuse block, to the left of the dimmer switch, through the sill plate, under the rear seat area, over the driver's side quarter panel wheel well and into the trunk. There are 2 wires in this section that need to remain in the interior of the car, wires labeled "C Pillar Light B+ #989" and "C Pillar Light Ground". Once in the trunk, route the wire down the side of the rear quarter panel, under the drivers' side tail light housing, between the rear panel and the gas filler neck, over to the passengers' side. **See Figures 6-8 A,B,& C**

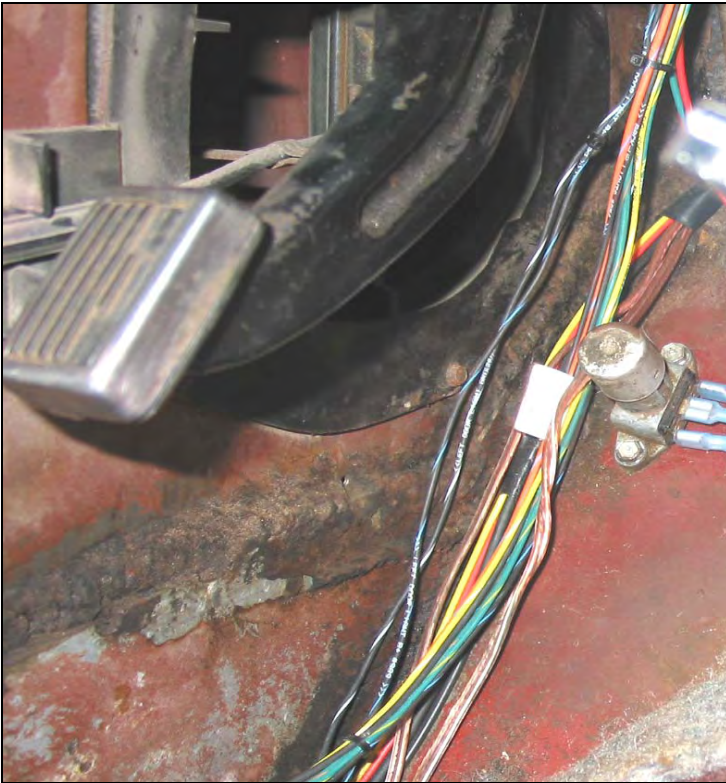

Figure 6-8A Tail Section Routing



Figure 6-8B Tail Section Routing



Figure 6-8C Tail Section Routing

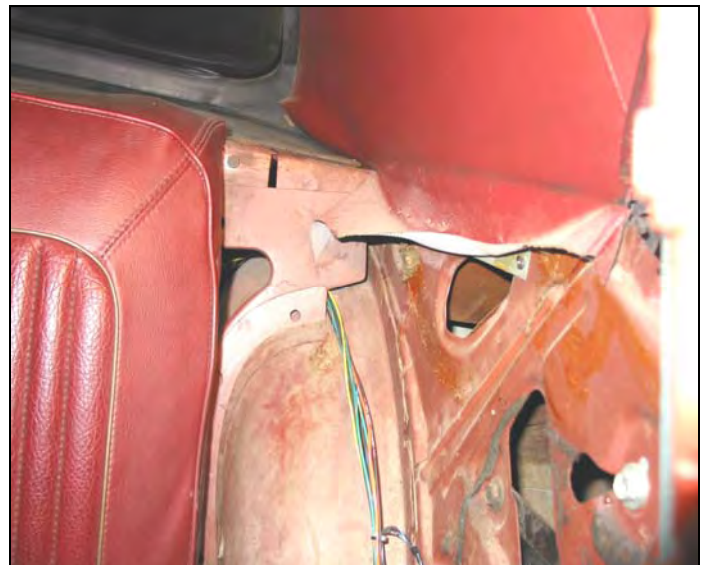

Figure 6-8D Tail Section Routing

6.1.8 The final sections of the harness to be routed are the **ENGINE SECTION** and **INTERIOR SECTION**. The **INTERIOR SECTION** must be routed towards the passenger side of the car, behind the bracing of the dash (**See Figure 6-9**) in order to get the **ENGINE SECTION** over to where it needs to be. The **ENGINE SECTION** of the harness is to be fed through the hole in the firewall under where the shock tower brace meets the firewall. You can install the grommet now or wait until the wires are pulled through the hole, then slide the grommet over the wires and into the hole. Running a string or a wire through the hole from the engine compartment into the interior may be the easiest way to get everything through the hole. (**See Figure 6-10**) Tape the **ENGINE SECTION** to the string/wire then pull the wire out into the engine compartment. After this section has been pulled through; carefully install the smaller grommet from the parts kit into the hole if you have not already done so. **See Figure 6-11**



Figure 6-9 Interior Section Routing



Figure 6-10 Engine Section Routing



Figure 6-11 Engine Section

6.2 Harness Attachment

Harness routing and shaping is and should be a time-consuming task. Taking your time will enhance the beauty of your installation. Please be patient and TAKE YOUR TIME!

- 6.2.1 Mold the harness to contour the firewall, fenders, core support or any other areas where wires or harness sections are routed. Remember to route the harness away from sharp edges, exhaust pipes, hood, trunk, and door hinges.
- 6.2.2 Attach harness groups to your automobile with clips or zip ties starting at the fuse block and working your way towards the outer harness circuits. The dash wires should be routed out of the way of any under-dash obstacles, such as vent levers, air conditioning controls, radio, etc.

Note: *Do not tighten tie wraps and mounting devices until each individual connection has been made on the particular circuit to be wire tied. Make all harness attachments LOOSELY, until all connections are made in each section.*

- 6.2.3 When using wire loom on the visible areas of the harness, it will need to be wire tied every 12" or so. This will make a very attractive assembly. Under the dash a tie installed every 6" or so will hold the wires in place nicely. Remember to take your time.

6.3 Grounding the Automobile

This Painless Wire Harness Kit includes the following ground wires: one front ground, one tail ground, one built-in ground wire for the horn, one ground wire for the interior and a ground wire for the accessory relay. Making these ground connections will be more thoroughly covered in the specific connection section. *Also, ground wires in this kit differ from those used by Ford for the 1969 and 1970 Mustangs. All BLK/WHT wires in this kit are ground wires.* Any additional circuits or accessories requiring a ground will have to be added.

- 6.3.1 Connect a Ground Strap or Cable (even a 10-gauge wire is too small) from the Negative Battery terminal to the automobile frame.
- 6.3.2 Connect a Ground Strap from the Engine to the frame. **DO NOT RELY UPON THE MOTOR MOUNTS TO MAKE THIS CONNECTION.**
- 6.3.3 Connect a Ground Strap from the Engine to the Body.

6.4 Terminal Installation and Making Connections

*Note: In the following steps you will be making the circuit connections. Before you start, you should carefully read **Sections 7.0**, as appropriate, and refer to **Section 8.0** as needed, DOUBLE-CHECKING your routing and length calculations before cutting any wires and making connections. The majority of the harness has been pre-terminated.*

- 6.4.1 Have all needed tools and connectors handy.
- 6.4.2 Select the correct size terminal for the wire application.

- 6.4.3** Determine the correct wire length and cut the wire. Remember to allow enough slack in the harness and wires at places where movement could possibly occur, such as automobile body to frame, frame to engine, etc. **Double-check your calculations.**
- 6.4.4** Strip the insulation from the wire. Strip only enough necessary for the type of terminal you are using. All of the terminals included in this kit require a ¼" strip length.
- 6.4.5** Insert the stripped portion of the wire into the crimp side of the terminal. Be careful as to not allow the individual wire strands to fray during insertion.
- 6.4.6** Crimp the terminal onto the wire using the proper jaw location on the crimpers.
Note: In step 6.4.6 be sure to use the proper jaw location on your crimpers. Most crimping tools have it color coded for which cavity to use. 18-22ga – Red, 16-14ga – Blue, and 12-10ga – Yellow. CAUTION: DO NOT OVER-CRIMP!
- 6.4.7** Many connections will be made throughout the installation process. Make sure each wire is FIRST properly routed and THEN attach. **DO NOT ATTACH FIRST AND ROUTE AFTERWARD.**
- 6.4.8** After all wires are terminated and securely attached, tighten the mounts and/or zip ties to secure the harness permanently.

6.5 Testing The System

CAUTION: IF YOU HAVE NOT YET DISCONNECTED THE BATTERY FROM THE AUTOMOBILE, DO SO NOW! DO NOT CONNECT THE BATTERY CHARGER WITH THE BATTERY CONNECTED.

- 6.5.1** Use a small (10 amp or less) battery charger to power up the vehicle for the first time to test the circuits. If there is a problem anywhere, the battery charger's low amperage and internal circuit breaker will provide circuit protection.
- 6.5.2** Connect the battery charger's NEGATIVE cable to the automobile chassis or engine block and its POSITIVE cable to the automobile's positive battery terminal lug.
- 6.5.3** INDIVIDUALLY turn on each light, ignition, wiper circuit, etc. and check for proper operation.
Note: The turn signals will not flash properly if you do not have both the front and rear bulbs installed and connected.
- 6.5.4** After all circuits have been checked, disconnect the battery charger and attach the vehicles battery cables to the battery. REPEAT STEP 6.5.3.

7.0 SPECIFIC CIRCUIT CONNECTIONS

- 7.1.1 Alternator/Regulator/Solenoid**
- 7.1.2** Connect HEADLIGHT SECTION wire #915 (BLK/YLW) to the Alternator Output post marked "Bat" or "B+". **See Figure 7-2**
- 7.1.3** Connect HEADLIGHT SECTION wire #914 (ORG) to the Alternator post marked "FLD".
- 7.1.4** Locate the Voltage Regulator Connector in the HEADLIGHT SECTION and plug it in to the Voltage Regulator, which is on the passenger side inner fender, under the starter solenoid.

- 7.1.5 Connect the yellow wire with the preinstalled female bullet connector to the Noise Capacitor. **See Figure 7-2**
- 7.1.6 Connect the Regulator Ground Wire (BLK/WHT) to one of the bolts holding the regulator in place.
- 7.1.7 Locate the Maxi Fuse Base in the parts kit and attach it to the passenger side shock tower. **See Figure 7-3**
- 7.1.8 Connect HEADLIGHT SECTION wire #916 to one side of Maxi Fuse Base. Using the remaining portion of wire #916 connect the other side of the Maxi Fuse Base to the B+ side of the starter solenoid. **See Figure 7-4**
- 7.1.9 Connect HEADLIGHT SECTION wire #919 to the "S" terminal on the starter solenoid. **See Figure 7-5**
- 7.1.10 If you are using a Ballast Resistor, connect HEAD LIGHT SECTION wire #970 (BRN) to the "I" terminal on the starter solenoid. **See Figure 7-5, also See 7.3.3**

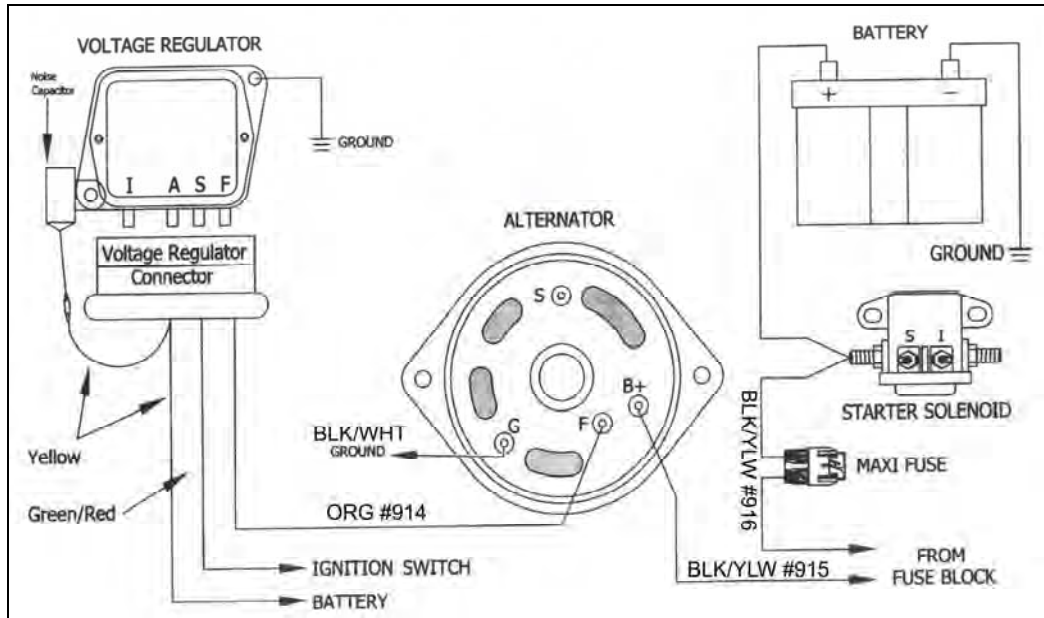

Figure 7-1 Alternator/Regulator Connections

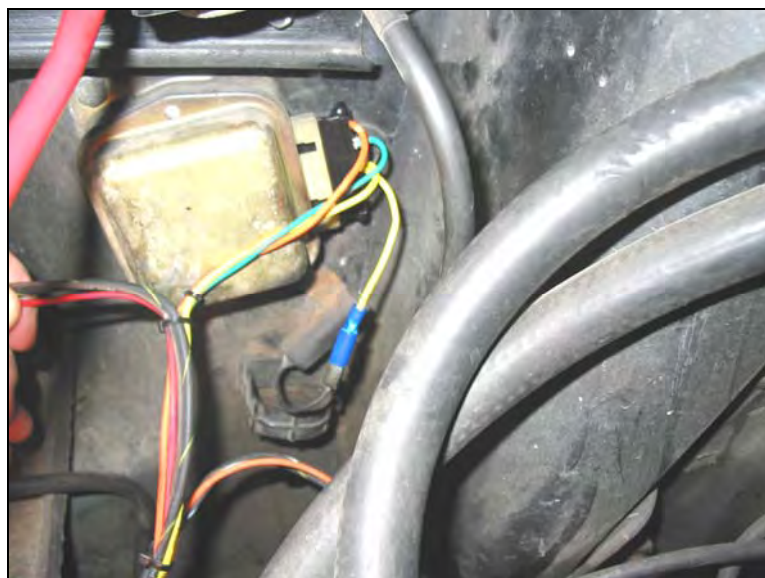

Figure 7-2 Regulator Connections

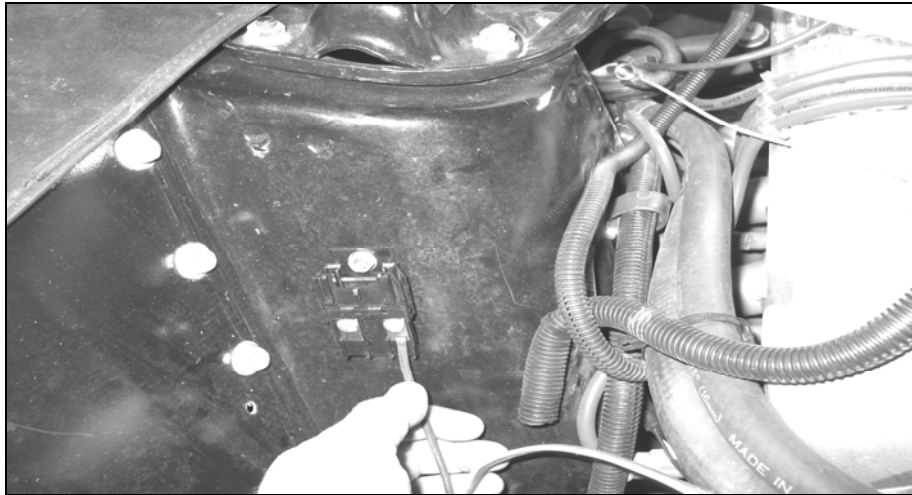

Figure 7-3 Maxi Fuse Base Mounting



Figure 7-4 Wire #916 Connections

7.2 High Amperage Alternator Kit

7.2.1 If an alternator with an output of more than 65 amps is being installed, a Painless High Amperage Alternator Kit, **Painless P/N 30709**, will need to be purchased.

7.3 Engine Section See Figure 7-5.

7.3.1 If using an aftermarket tachometer, connect ENGINE SECTION wire #923 (RED/YLW) to the negative side of the ignition coil.

7.3.2 Connect ENGINE SECTION wire #920 (RED/GRN) to one side of the ballast resistor. Connect the other side of the ballast resistor to the positive post on the ignition coil. *Note: If using a ballast resistor be sure to mount it away from other wiring and hoses. It gets very hot during operation.*

- 7.3.3** ENGINE SECTION wire #970 (BRN) is used both on a point's type ignition system and a Duraspark II System. It is to be connected directly to the positive post on the ignition coil or the coil feed side on the ballast resistor. The other end, located in the HEADLIGHT SECTION, is to be connected to the "I" terminal on the starter solenoid. See 7.1.8 also See Figure 7-5.

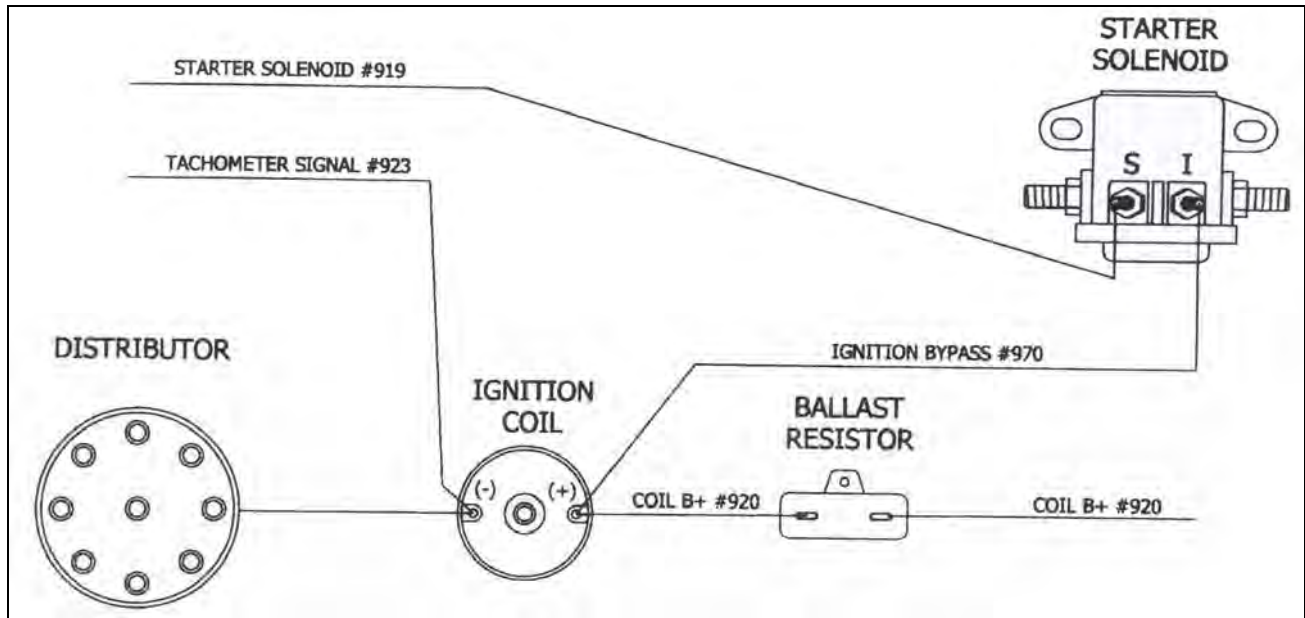

Figure 7-5 Points Type Ignition Diagram

- 7.3.4** Connect ENGINE SECTION Temperature Sending Unit wire #921 (RED/WHT) to the engine temperature sending unit. Connect ENGINE SECTION Oil Pressure Sending Unit wire #922 (WHT/RED) to the engine oil pressure sending unit. Small ring terminals and nuts have been supplied in the parts kit to make these connections.
- 7.3.5** Connect the ENGINE SECTION Electric Choke B+ wire #954 (RED) to the electric choke.

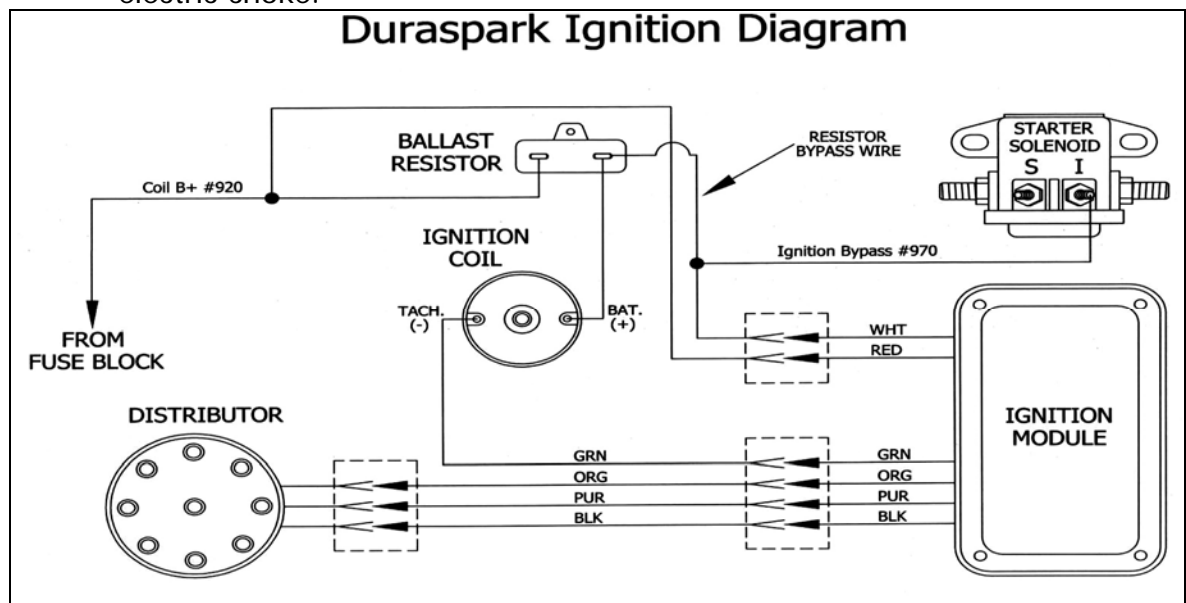

Figure 7-6 Ford Duraspark II Systems (Ford Electronic Ignition)

- 7.3.6** Neutral Safety/Backup Light Switch wire #'s 958, 956 and #919 (2 wires) all breakout from the firewall in the ENGINE SECTION. #958 (BLK/RED) is the power source to the switch for the backup lights and #956 (BLK/RED) is the wire connected to the actual bulbs. Wire IGNITION SWITCH START #919 (RED/BLU) comes from the start terminal on the Ignition Switch and provides the start signal to the Neutral Safety switch. Wire STARTER SOLENOID #919 (RED/BLU) carries the start signal from the Neutral Safety switch to the Starter Solenoid. **See Figure 7-7.**

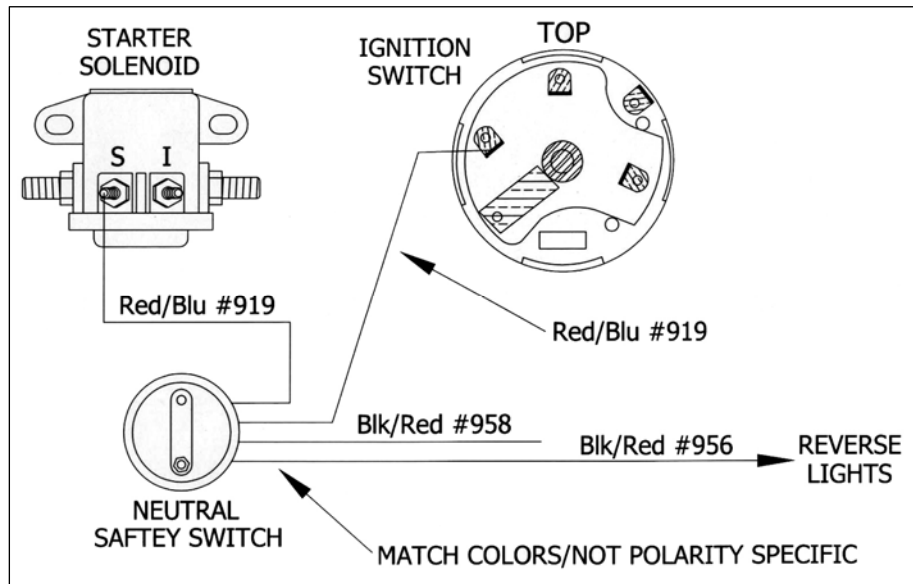

Figure 7-7 NEUTRAL SAFETY SWITCH

7.4 Headlight Section

- 7.4.1** Locate the 2 wires labeled Brake Warning #968 (PUR). These 2 wires will be located close to the aluminum fire wall plate you installed earlier. Using splices supplied with this kit, splice the original factory brake warning switch connector onto these 2 wires, it makes no difference which PUR wire goes where. Now with the connector installed on the new harness, plug the connector into the brake warning switch. **See figure 7-8**
- 7.4.2** Following the HEADLIGHT SECTION towards the front of the car, you will find 2 wires next to the core support. These wires are labeled Washer B+ #983 (GRN) and Washer Pump Ground (BLK/WHT). Using splices supplied with this kit, splice the original factory washer pump connector onto these 2 wires, matching the factory wire colors to the new. Now with the connector installed on the new harness, plug the connector into the washer pump. **See figure 7-9**
- 7.4.3** Install the driver's side marker light connector into its housing on the lower fender. Make certain that a bulb is installed to avoid having to take the connector back out to install one.
- 7.4.4** The next group of wires will be for the Left Turn Signal and Park Lamp. Using bullet connectors included with the parts kit, match the colors and connect the following wires onto the factory molded connector: Left Turn Signal #926 (GRN/WHT), Park lights #927 (BLK/YLW), Left Turn/Park Ground (BLK/WHT)

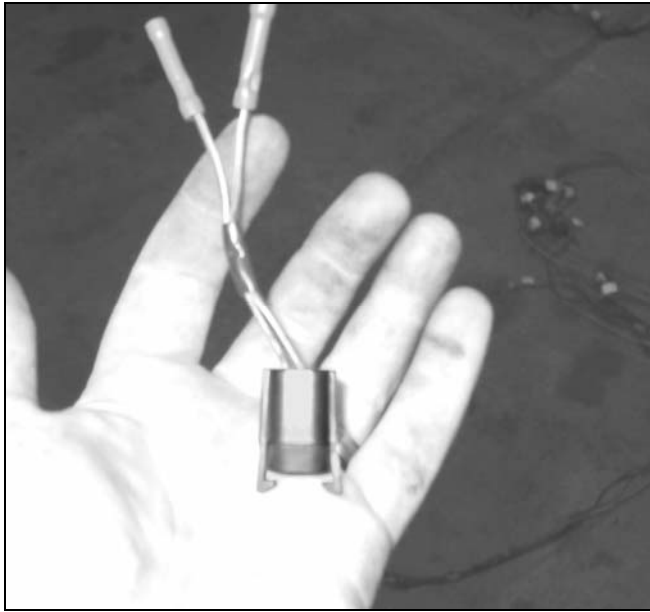

Figure 7-8 Brake Warning Connector

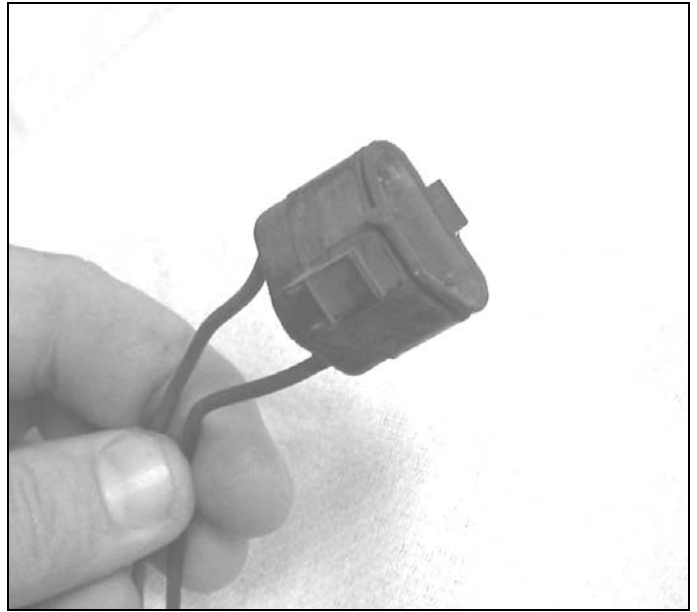

Figure 7-9 Washer Pump Connector

- 7.4.5** Locate the connector for the Left Headlamp. It is the black connector with 3 wires: "High Beam #908" (GRN/BLK), "Low Beam #909" (RED/BLK), "Left Headlamp Ground" (BLK/WHT). Plug this connector into the back of the headlamp. Make certain that the connector is going on straight; the tabs on the back of the headlamp have a tendency to bend. **See Figure 7-11**
- 7.4.6** The other black connector with 2 wires, "High Beam #908" (GRN/BLK) and "Left High Beam Ground" (BLK/WHT), is for the 1969 models. This connector plugs into the separate high beam located in the grille; use the same caution as the headlamp connector. For the 1970 models this connector can be cut off and the wires tied or taped into the harness. **See Figure 7-11**
- 7.4.7** "Horn B+ #924" needs to be routed and connected to the driver's side horn.
- 7.4.8** All BLK/WHT ground wires located in the HEADLIGHT section share the same ground wire. This is a 4' wire labeled "Front Ground" located close to the center of the core support. Using a ring terminal, connect this wire to a good clean ground. One of the bolts on the center grill support makes for a good ground. **See Figure 7-10**
- 7.4.9** Repeat all of the above steps to the components located on the passenger's side.



Figure 7-10 Front Ground Connection

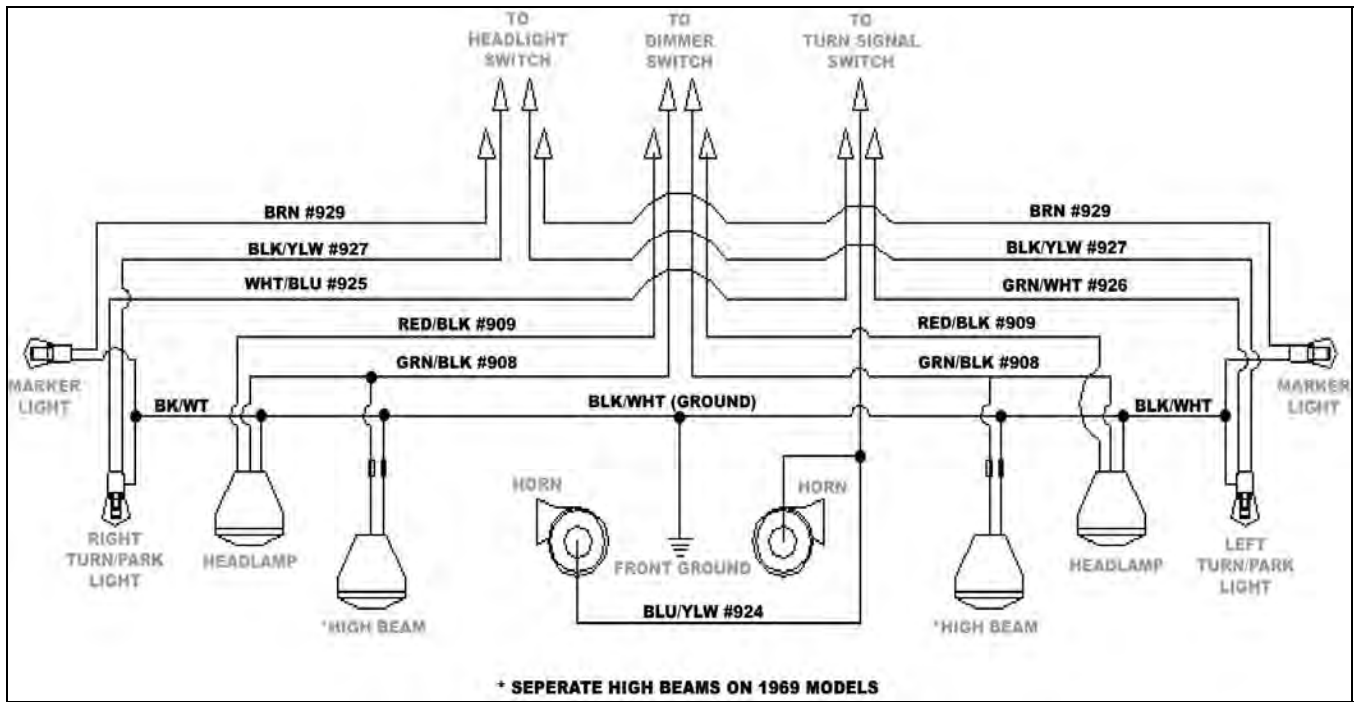

Figure 7-11 Headlight Section Connections

7.5 Rear Light Section

7.5.1 The REAR LIGHT SECTION consists of: Taillights, Stoplights, Left and Right Turn Signals, Trunk Light, Backup Lights, License Plate Light, Dome Light, a Ground wire and Fuel Sending Unit.

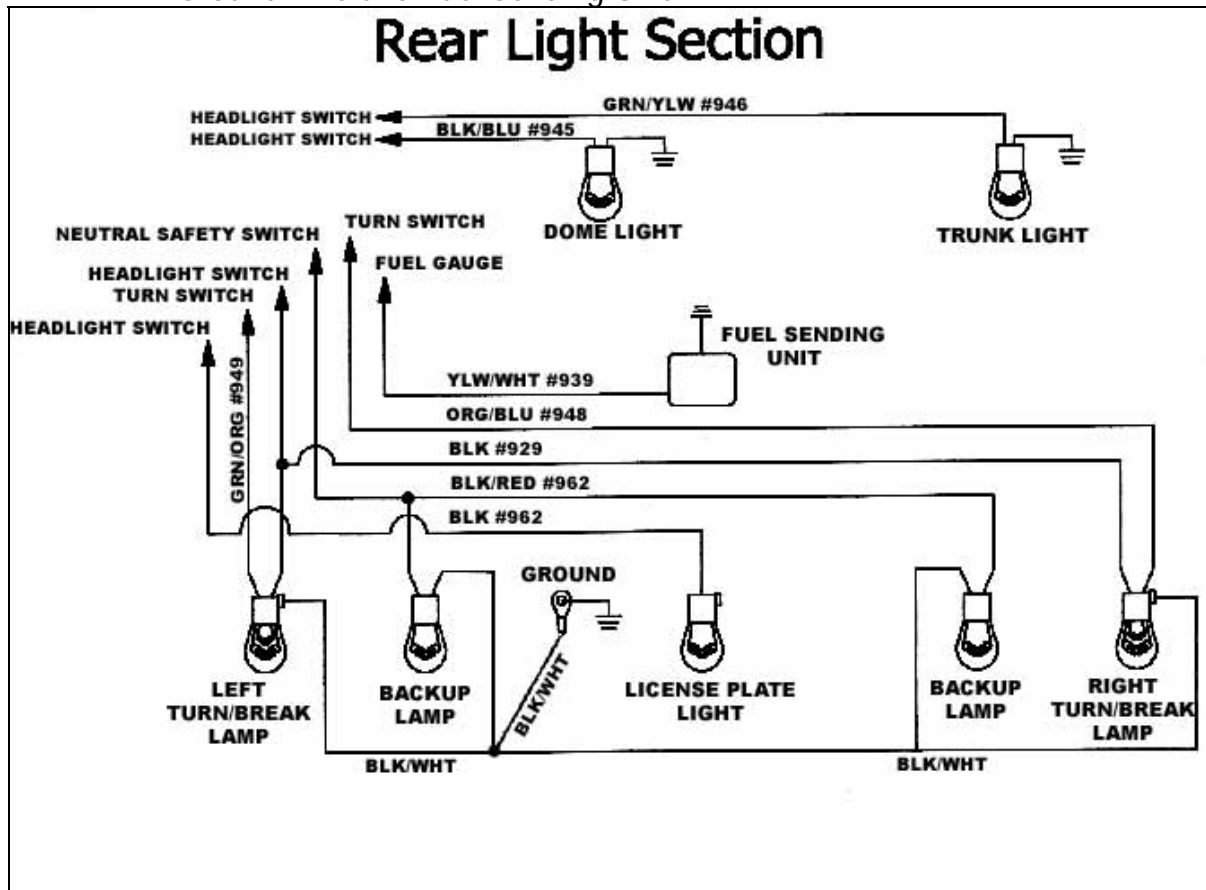

Figure 7-10 Rear Light Section and Dome Light

- 7.5.2 Locate the factory lead coming from the dome light in the upper left side of the trunk. Connect the wire labeled "To Dome Light #945" (BLK/BLU) to this lead. If no lead exists, route wire #945 to the dome light.
- 7.5.3 Trunk Light B+ #946 needs to be connected to the truck light switch on models equipped with this feature. A power wire from the switch to the trunk light must be supplied by the customer.
- 7.5.4 "Fuel Sending Unit #939" (YLW/WHT) needs to be connected to the factory fuel sending unit wire coming from the tank into the trunk. If this wire was disconnected at the sending unit and not cut during removal of the factory harness, connect #939 to the fuel sending unit.
- 7.5.5 Install the driver's side marker light connector into its housing. Make certain that a bulb is installed to avoid having to take the connector back out to install one.
- 7.5.6 Using bullet connectors included with the parts kit, match the colors and connect the following wires onto the factory molded connector coming from the drivers' side reverse lights: "Back Up Lights #956" (BLK/RED) and "Left Rear Back Up Ground" (BLK/WHT)
- 7.5.7 All BLK/WHT ground wires located in the Rear Light section share the same ground wire. This wire, labeled "Ground", can be found coming from the group of wires near the left rear tail light. Using a ring terminal, connect this wire to a good clean ground.
- 7.5.8 A new tail light socket has been provided. With a bulb installed, push the new socket into the tail light lens. **See Figure 7-11**
- 7.5.9 Connect wire "License Plate Light #962" to the lead coming from the license plate, or if no lead exists, to the light itself.
- 7.5.10 Repeat the above steps to connect the passenger side marker light, reverse light, and the right tail/stop/turn lights.

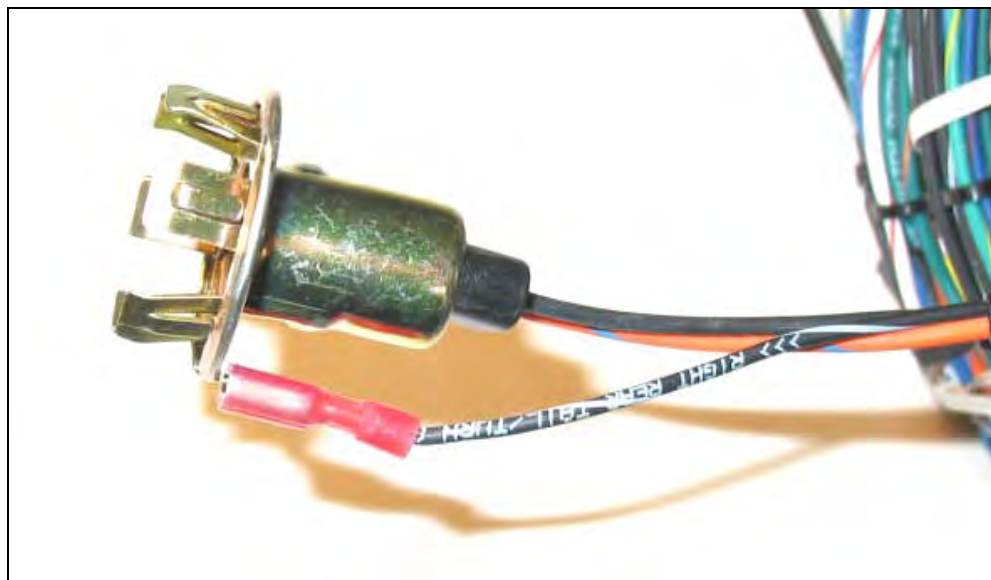

Figure 7-11 Tail Light Socket

7.6 Interior Lighting

- 7.6.1** "Left C Pillar Light B+ #989" (BLK/BLU) and "C Pillar Light Ground" (BLK/WHT) were routed when the REAR LIGHT SECTION was routed. These 2 wires need to be connected to the drivers' side C Pillar Light on models equipped with this feature. The same goes for the passenger side C pillar light. Route the wires under the door sill plate, up the rear quarter wheel tub and to the C pillar light.
- 7.6.2** Models equipped with door panel lights will need to route and connect INTERIOR SECTION wires "Left Door Light B+#989" (BLK/BLU) and "Door Light Ground" (BLK/WHT) to the driver side door lights. Do the same for the passengers' side door lights.
- 7.6.3** With the door jamb switches removed from the door jamb, route the left door switch wires "To Left Door Jamb Switch B+ #987" (GRN/YLW) and "To Left Door Jamb Switch B+ #987" (BLK/BLU) through the door jamb switch holes. You may have to insert a wire or string into the hole, like what was instructed in **6.1.8**, in order to get the wires through. The original connector from the factory harness will need to be reused. Using a small screwdriver, press in the retaining tab on the side of the factory terminal and pull the terminal from the connector. **See Figure 7-12** Connect the 2 new wires to the door jamb switch connector; it makes no difference which wire goes where. Snap the connector onto one of the new door jamb switches provided and then install the switch into the door jamb. Connect the jamb switch for the passengers' side in the same manner. **See Figure 7-13**



Figure 7-12 Door Jamb Switch Connector



Figure 7-13 Door Jamb Switch

- 7.6.4** Locate wire "Courtesy Light #989" (BLK/BLU) and connect it to the drivers' side courtesy light. There is also a "Courtesy Light #989" (BLK/BLU) wire located in group of wires labeled "Glove Comp." This wire needs to be connected to the passenger side courtesy light.

7.7 Dimmer Switch Connections

7.7.1 Connect the Dimmer switch connector to the dimmer switch.

7.8 Headlight Switch

7.8.1 Connect the HEADLIGHT SWITCH wires as illustrated in **Figure 7-14**. Extra terminals have been provided in the parts kit to allow the customer to reuse their factory connector.

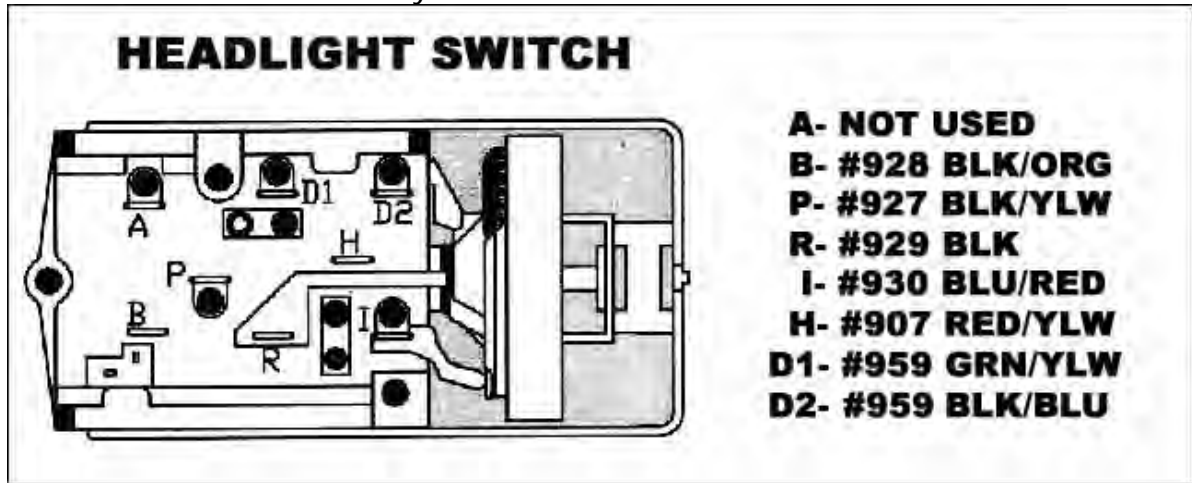

Figure 7-14 Headlight Switch Connections

7.9 Turn Signal Switch and Brake Light Switch

7.9.1 The original Turn Signal Switch Connector from the old harness will need to be re-used. Carefully remove the original wires, **ONE WIRE AT A TIME, replacing them with the new wires. The new wire colors match the original colors in the old harness.** Use a small pair of needle nose pliers or a flat screwdriver to remove the original terminals from the connector cavities.

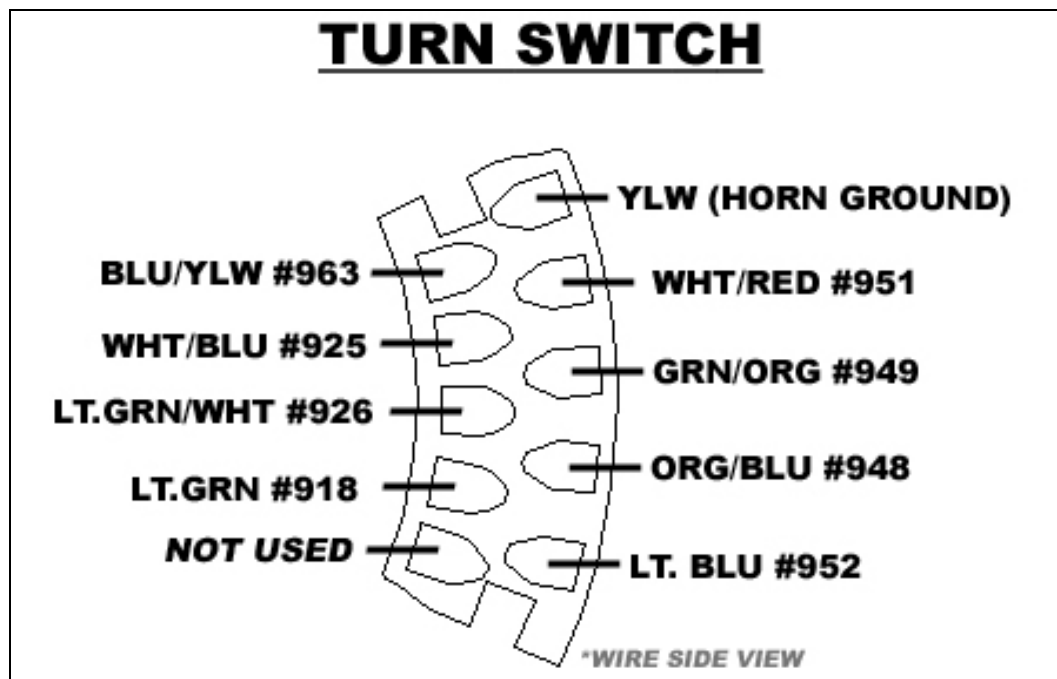

Figure 7-15 Turn Signal Switch Pin Out

- 7.9.2** Route the BRAKE SWITCH wires "Brake Switch B+ #917" (GRN/RED) and "Brake Switch Output #918" (GRN) down to the Brake Switch located on the brake pedal. Leave enough slack in the wires to allow for the brake pedal movement. These wires **are not** polarity specific, in other words it does not matter which wires goes onto each side of the switch. **See Figure 7-16.**

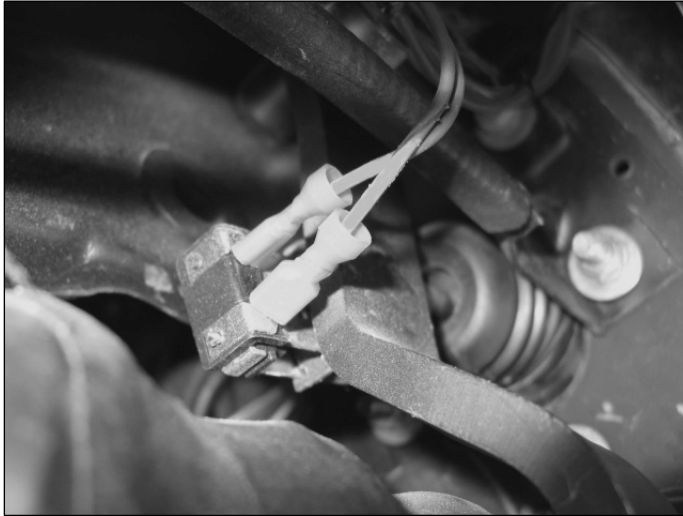

Figure 7-16 Brake Switch

7.10 Gauge Cluster Section

- 7.10.1** The connector supplied on the Painless is installed to be used on factory clusters that DO NOT have a tachometer. **The connector must be re-pinned in order to make the connections to gauge clusters with a factory tachometer.** To remove the terminals from the connector, insert a paperclip or small flat head screwdriver and press in the terminal's locking tang as shown in **Figure 7.17**. If your cluster does not have a tach, you can simply plug the connector in, however see **7.10.2** about the unused wires.

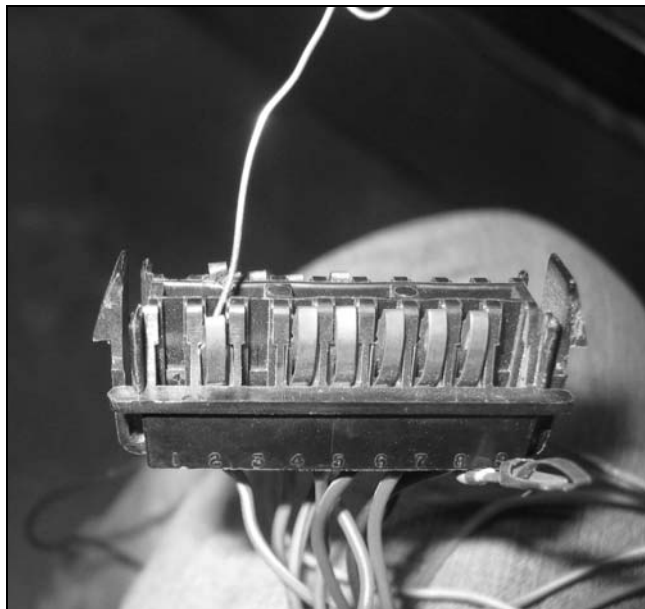

Figure 7-17 Gauge Cluster Connector

7.10.2 Use **Figure 7-18** to correctly pin out your gauge cluster connector. Some wires share the same number and or color. Not all wires will be used. No matter which of the 2 factory clusters you have, with a tachometer and without, you will have unused wires. These wires will either be 2 UNPROTECTED constant battery power wires or 3 switched power wires. These unused wires will need to be taped and properly stowed away to prevent a short. Use male and female bullet terminals from the parts kit to connect the Red #972 and Yellow #972 wires together for applications where a factory tach is being used. This is a step that must not be skipped. See **Figure 7-18** for the wires not used for each configuration.

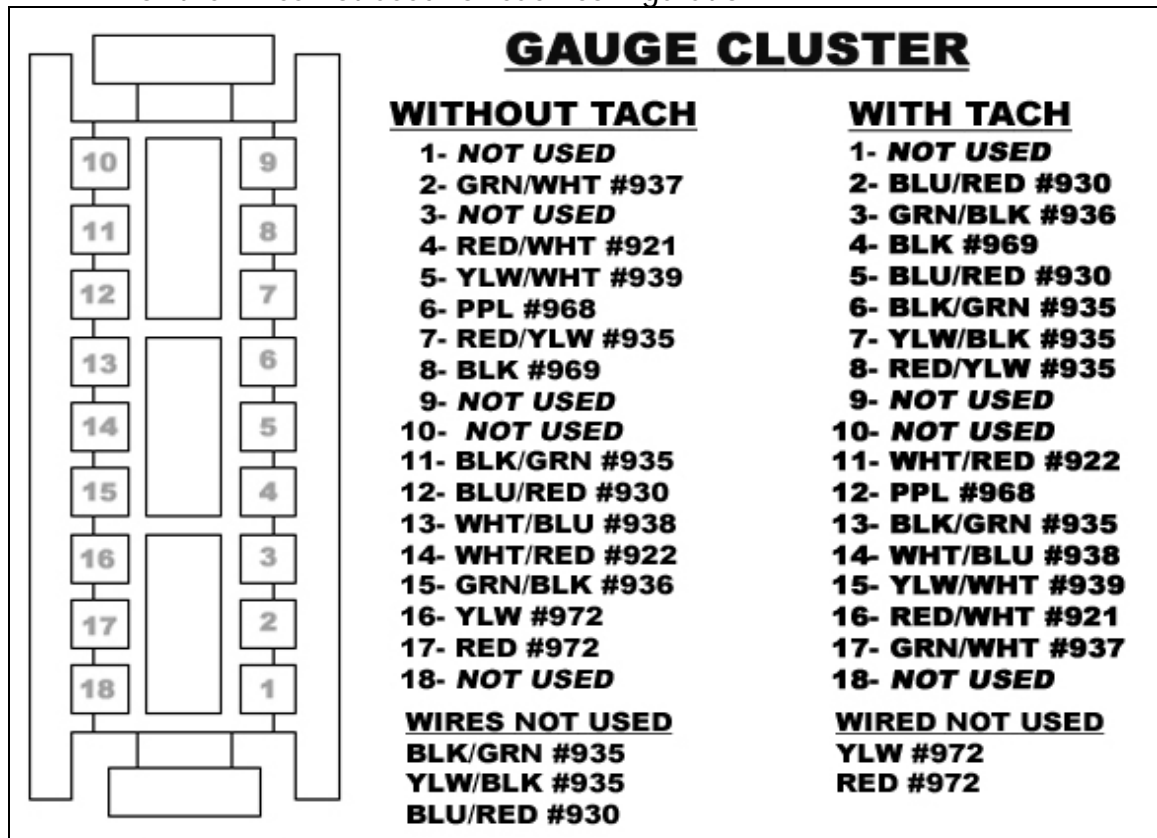

Figure 7-18 Gauge Cluster Pin Out

7.10.3 For those who are using a factory tachometer, the Coil B+ #920 (RED/GRN) wire loop located in the Gauge Cluster Group needs to be cut and connected to the leads coming from the tachometer. For those who do not have a factory tach, this step should be skipped and the wire should be left as a loop. See **Figure 7-19**

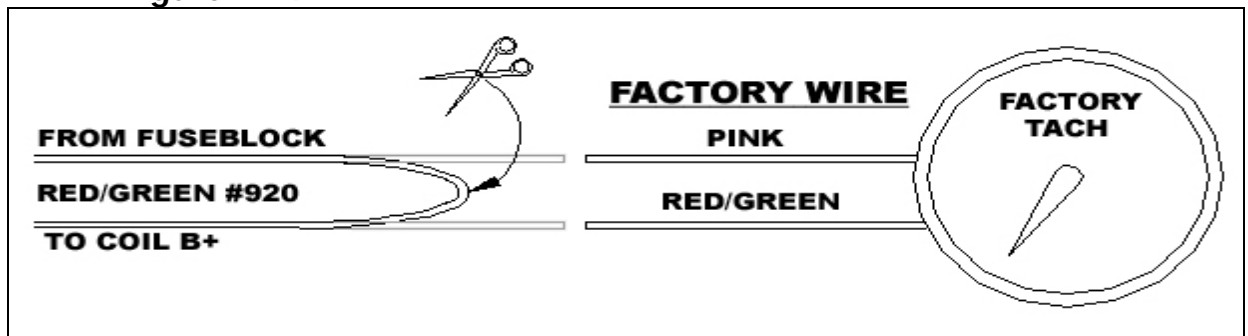

Figure 7-19 Factory Tach. Connections

7.10.4 The harness you have purchased also has provisions, located in the Gauge Cluster group, for aftermarket tachometer connections. If using an aftermarket tach, wire #923 (RED/YLW) is the tach signal wire. This wire should have been also connected to the negative side of the coil during the ENGINE SECTION installation **See 7.3.1**. Wire #930 (BLU/RED) needs to be connected to the tach light. If no aftermarket tach is being used, simply tape and stow these wires in the harness. Wire #930 could also be used to power illumination to any other aftermarket gauges.

7.11 Ignition Switch

7.11.1 Due to the different locations of the ignition switch between the 1969 models and the 1970 models, modifications to the Ignition Switch Group of wires may be required. Those with the steering column mounted ignition switch found on the 1970 models may need to cut the zip tie, located where the Ignition Switch wires breaks out from the main harness, to get a little bit of extra length to make the connection to the connector at the steering column.

7.11.2 The original Ignition Switch connector must be reused to make the following connections. **See Figures 7-20A and 7-20B** To unpin the factory terminals, follow the same procedure used to remove the gauge cluster pins. The ignition switch terminals can be stubborn, but with patience, they will come free. The locking tang on the terminal is on the opposite side of the terminal of the split. Care should be taken as not to break or disfigure the original connector. There is however a replacement connector pigtail available for the ignition switch found on the 1969 models, *Car Quest part# US45H*

7.11.3 Once the connector is unpinned, use Figure 7-20C to connect the wires from the Painless harness to the ignition switch connector. With the connector properly pinned out, connect the connector to the ignition switch.

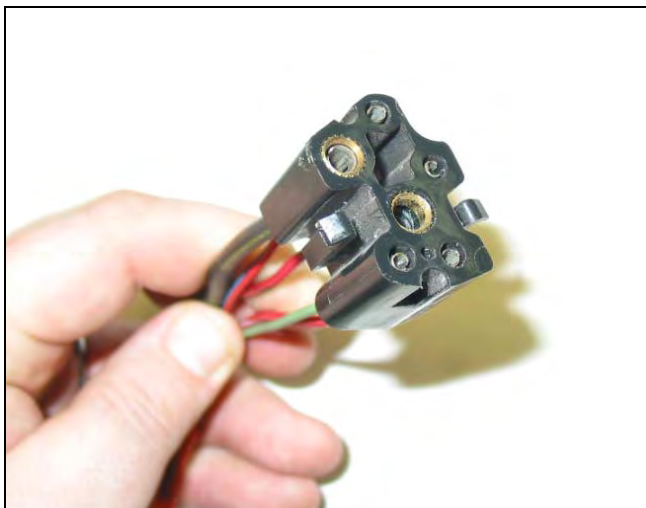

Figure 7-20A 1969 Ign. Sw. Connector

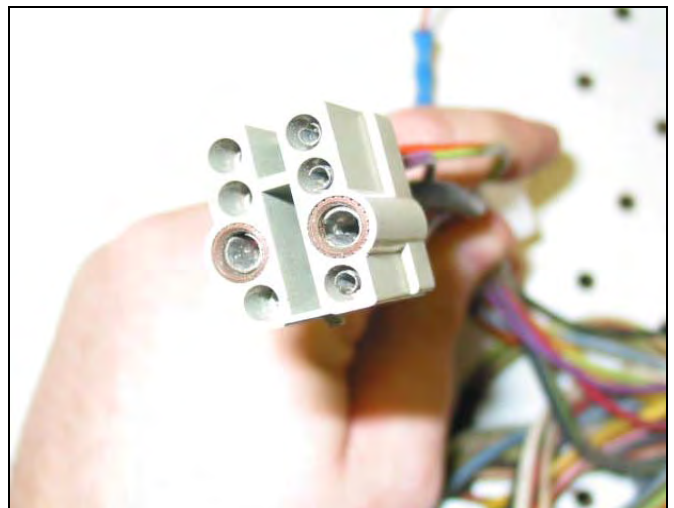

Figure 7-20B 1970 Ign. Sw. Connector

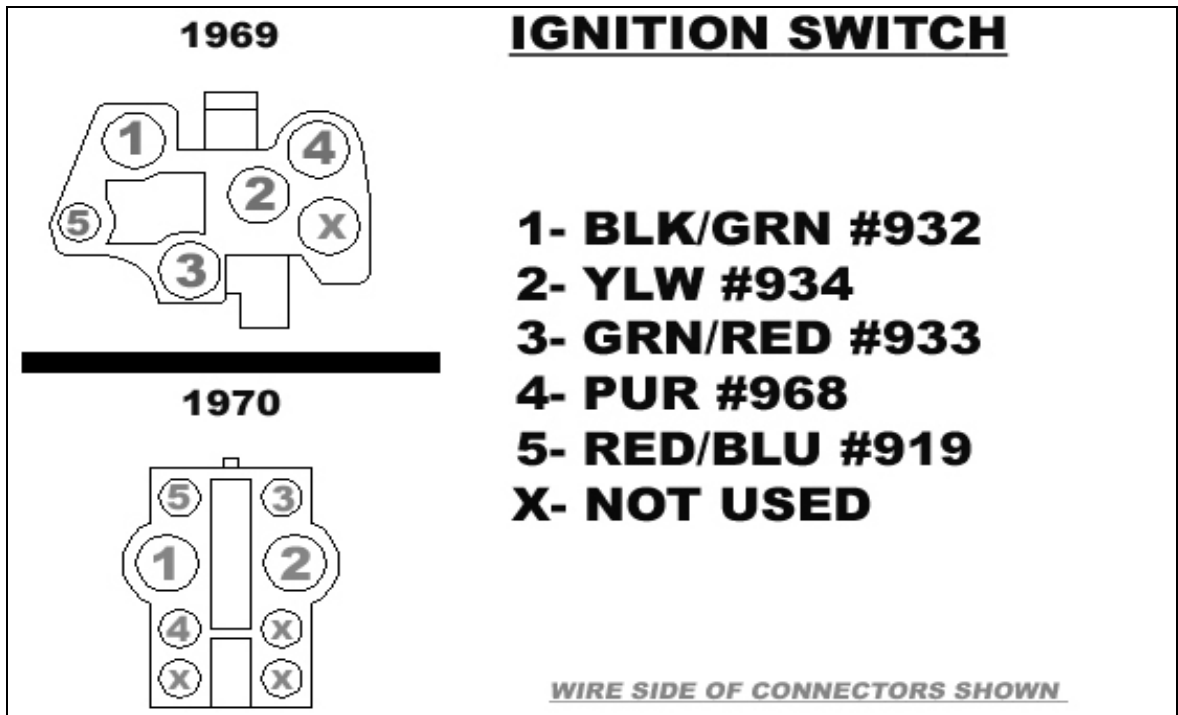

Figure 7-20C Ignition Switch Connection

7.11.4 Ign. Switch Light #930 (BLU/RED) is supplied for the 1969 models. Splice this wire onto the ignition switch illumination lamp located on the metal bracket behind the dash which helps hold the ignition switch. The factory Ford color (BLK/YLW) was not used in order to keep all gauge and back lighting wires the same color. If an ignition switch lamp is not being used, tape the end of the wire and stow it away in the harness. This wire could also be used to power illumination to any aftermarket gauges. **See Figure 7-21**

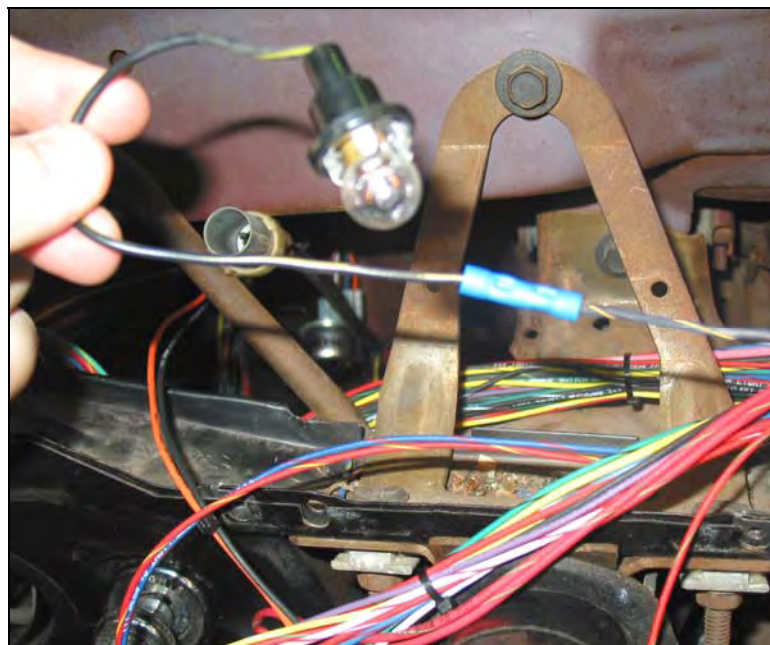

Figure7-21 Ignition Switch Lamp

7.12 Wiper Switch/Wiper Motor

- 7.12.1 Locate the group of wires labeled Wiper Switch. Connect these wires to the wiper switch according to **Figure 7-22**. Additional terminals have been supplied in the parts kit to allow the customer the option of using their factory connector.

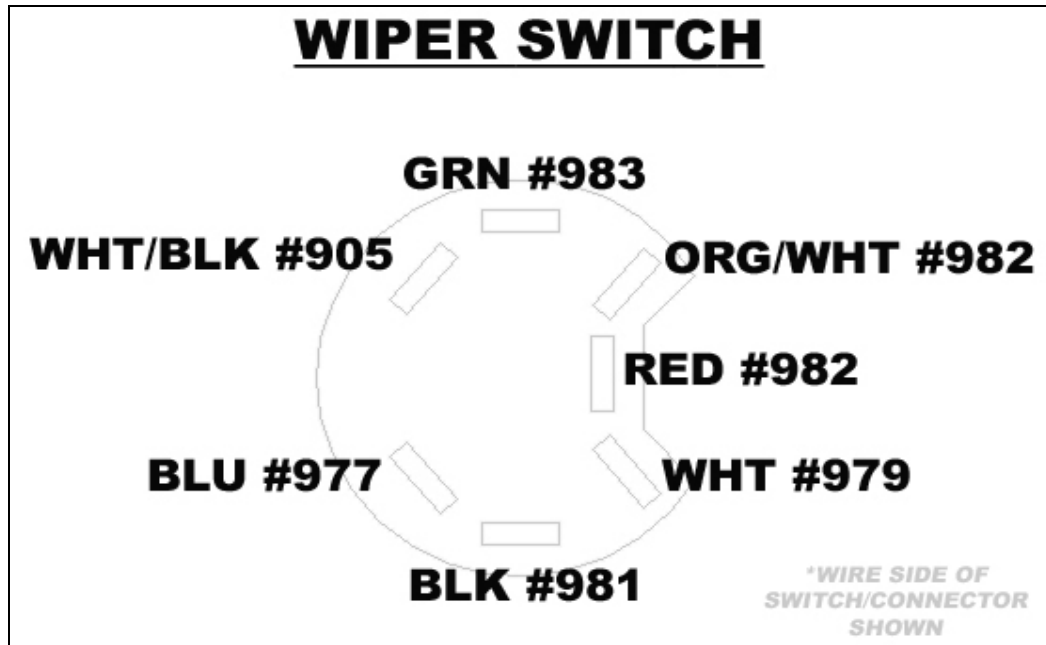

Figure 7-22 Wiper Switch Connection

- 7.12.2 Locate the 4 wiper motor wires in the ENGINE SECTION. Using male and female bullet terminals connect these 4 wires to the factory lead coming through the wiper cowl. Terminals were left off and extra length was given to these wires to allow the customer the option of running the wires through the wiper cowl to the motor for a cleaner install. Match the new wires of the Painless harness to the factory colors. **See Figure 7-23**

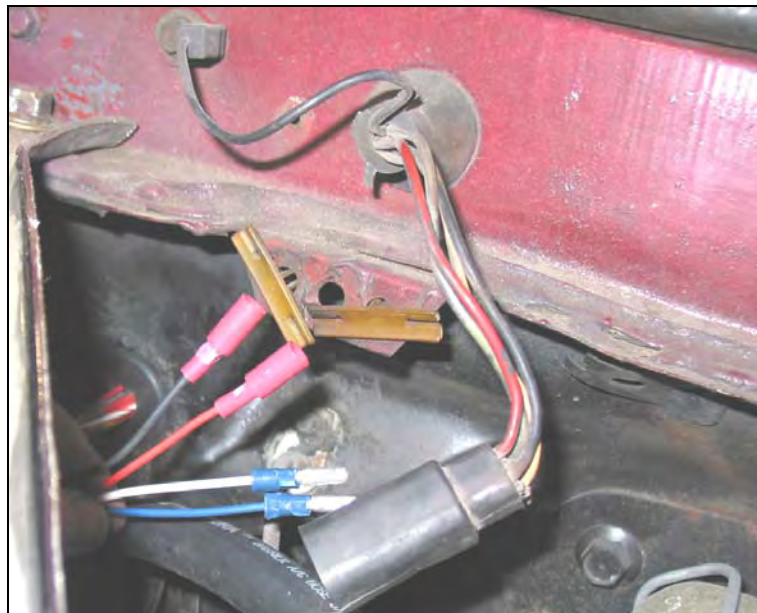

Figure 7-23 Wiper Motor Terminals and Connector

7.13 Interior Ground

- 7.13.1** All BLK/WHT ground wires located in the Interior Section share the same ground wire. This wire, labeled "Interior Ground", can be found at the same breakout from the main harness as the Engine Section. Using a ring terminal provided in the parts kit, connect this wire to a good clean ground, such as the bracing behind the instrument cluster. **See Figure 7-24**



See Figure 7-24 Interior Ground

7.14 Console Wiring

- 7.14.1** The Console group of wire consists of 6 wires. Route these wires down behind the dash and to the console.
- 7.14.2** Connect *Console Light B+ # 930* (BLU/RED) and the *Console Light Ground* (BLK/WHT) to the console light
- 7.14.3** Connect *Gear Ind. Light B+ # 930* (BLU/RED) and the *Gear. Ind. Light Ground* (BLK/WHT) to the Gear Indicator Light located on the shifter.
- 7.14.4** Connect *Cigar. Lighter B+ #903* (BLU/WHT) and *Cigar. Lighter Ground* (BLK/WHT) to the Cigarette Lighter (Located in the dash on the '70 models).

7.15 Heater Switch and Blower motor

- 7.15.1** A new heater switch connector has been supplied. Simply plug this connector onto your factory heater switch. See **Figure 7-25 and 7-26**. *Figure 7-26 shows the location of the heater switch. A connector was not available at the time the photo was taken.*
- 7.15.2** If your model is equipped with a factory A/C, follow the proceeding steps. If you car does not have the factory A/C skip to **7.15.6**.
- 7.15.3** Locate the 6" green wire coming from the heater switch connector. The end will need to be connected to the back tab on the A/C Mode Switch. **See Figure 7-26**

- 7.15.4** Connect the *A/C Mode Switch to De-Ice Switch #994* (LT.GRN) wire to the front tab on the A/C Mode Switch. **See Figure 7-26**
- 7.15.5** Located behind the passenger side dash panel there is an A/C De-Icing Switch. Connect the *A/C Comp. Clutch Solenoid #998* (GRN) wire and the *A/C Mode Switch to De-Ice Switch #994* (LT.GRN) wire to the De-Icing Switch. It makes no difference where each wire connects. **See 7-27**

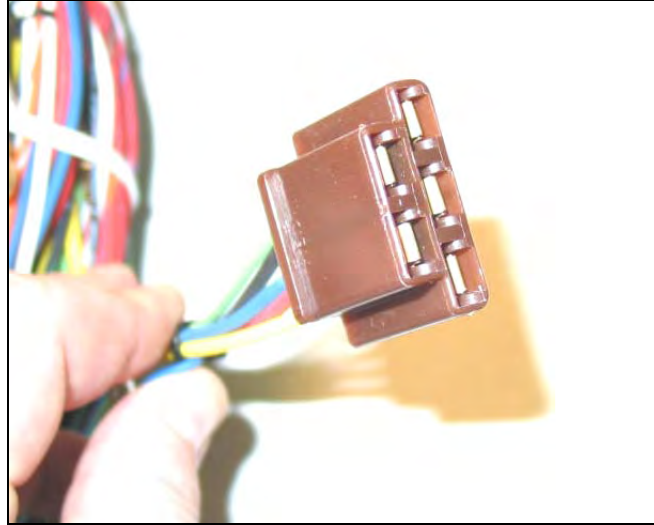

Figure 7-25 Heater Switch Connector



Figure 7-26 A/C Mode Switch

- 7.15.6** Connect the 3 blower motor wires to the blower motor. If the factory pigtail is still on hand, you can match the colors to the existing factory pigtail. If not, connections can be made to the blower motor as followed: the Low #975 (RED) wire will connect to the top tang, High #973 (BLK) will connect to the bottom tang, and Med. #974 (BLU) will connect to the side tang.



Figure 7-27 A/C De-Icing Switch

7.16 Radio

- 7.16.1 Connect the 2 power wires, *Constant* #940 (RED) and *Switched* #941 (YLW/BLK), to the appropriate power locations on the radio.
- 7.16.2 Connect *Radio Light B+* #930 (BLU/RED) to the radios illumination.

7.17 Glove Compartment

- 7.17.1 Not all models will have the following features. If your model is not equipped with a Map Light or Clock, tape the ends and stow away the entire Glove Comp. Group.
- 7.17.2 Locate the group of wires labeled Glove Comp.
- 7.17.3 Connect wires *Map Light B+* #900 (GRN/YLW) and *Map Light Switch Ground* (BLK/WHT) to the molded connector coming from the Map light. Connect the *Glove Box Light Switch* #990 (BLK) to the lead coming from the Map Light Switch. See **Figure 7-28**

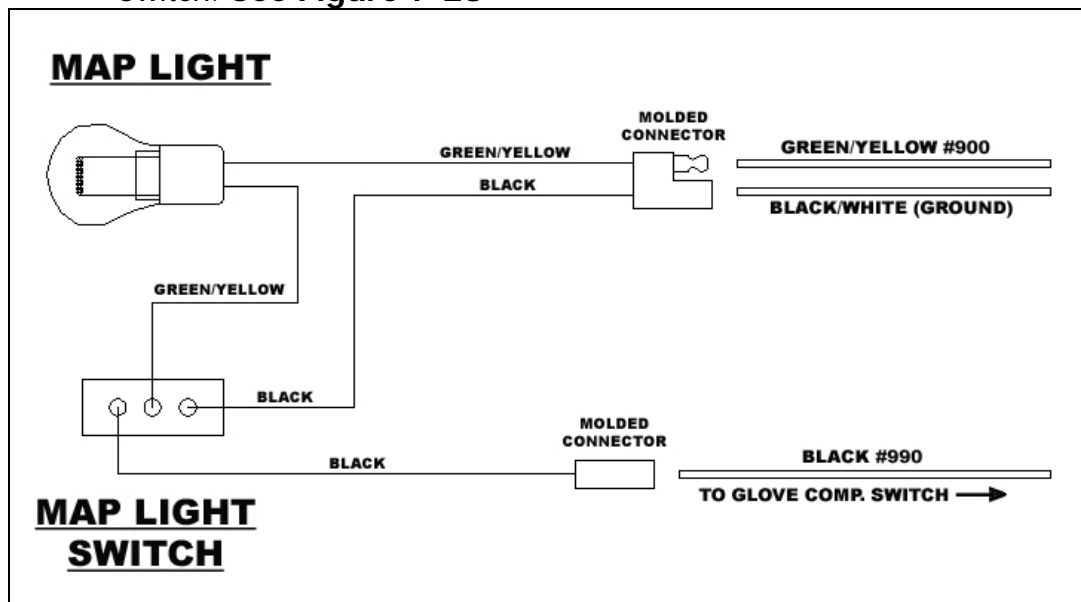

Figure 7-28 Map Light Wiring

- 7.17.4 The opposite end of wire #999, connected in the step above, is to be connected to the glove compartment switch. This wire will ground the Map Light, complete the circuit, causing it to illuminate when the glove compartment door is opened.
- 7.17.5 To make the clock connections See Figures 7-29 A or B. Figure 7-29A allows the installer to retain the factory clock harness, eliminating splicing and extra work. Figure 7-29B shows the connections and splices that must be made in order for things to function properly without the use of a factory harness.

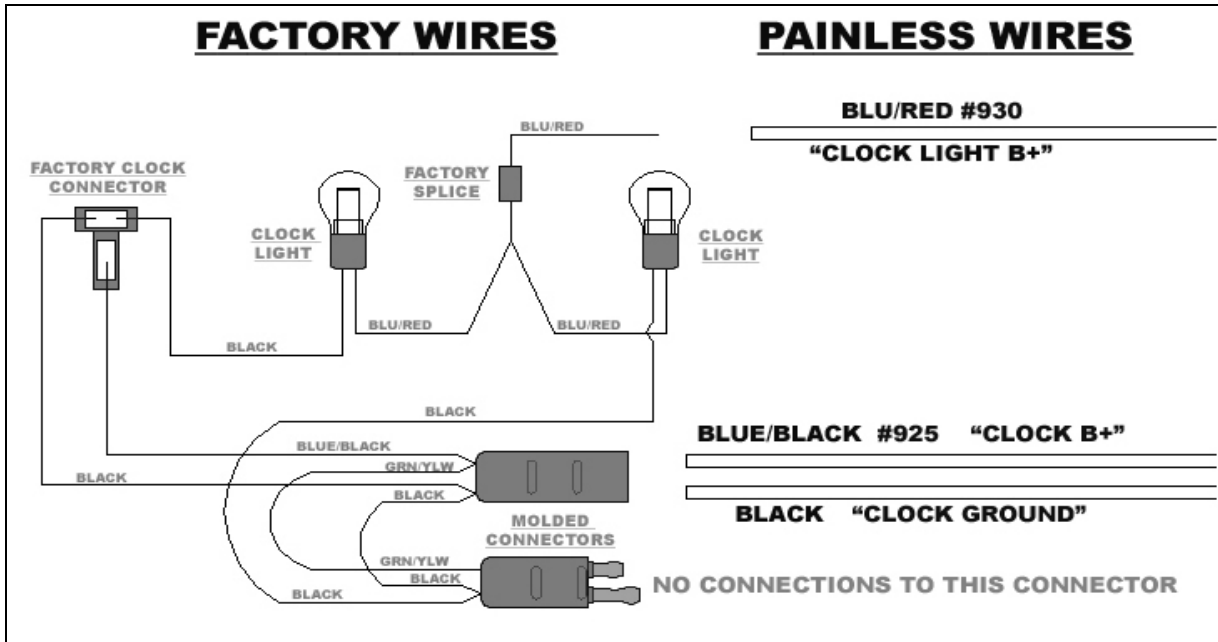

Figure 7-29A Clock Wiring (using factory clock harness)

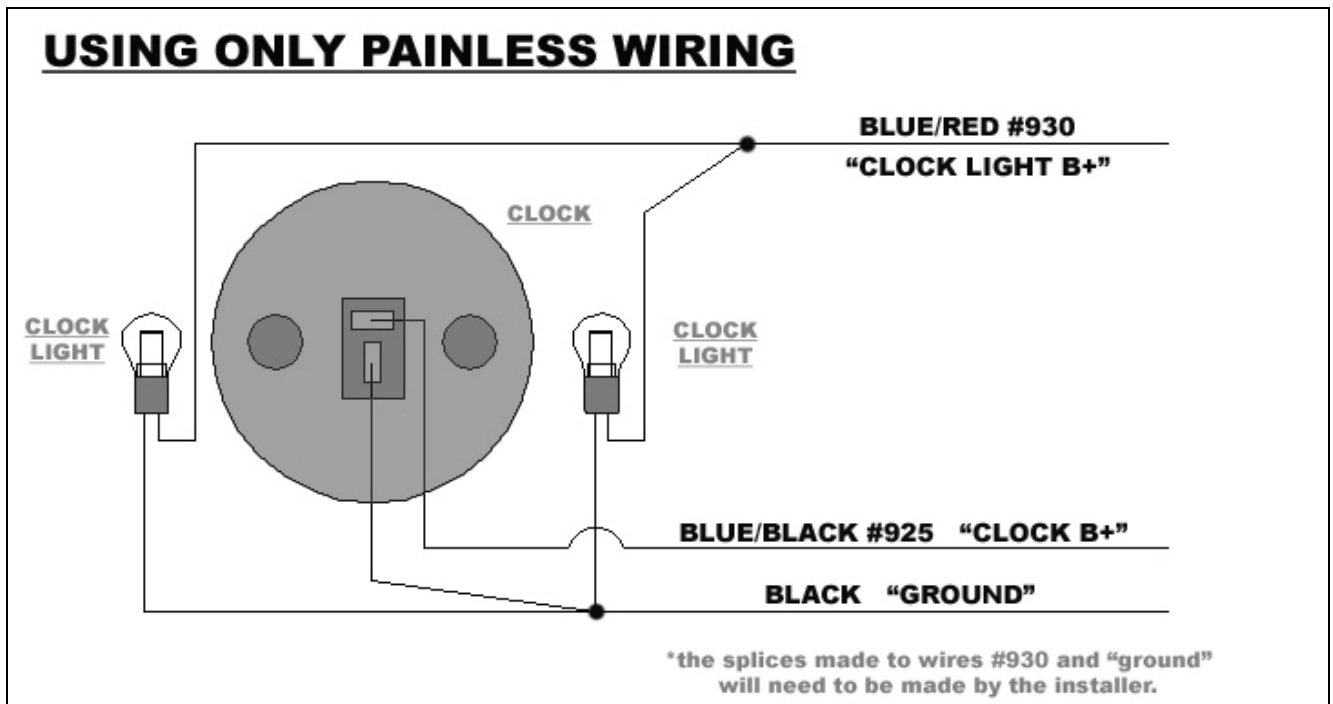

Figure 7-29B Clock Wiring

7.18 Accessory Relay

7.18.1 The final component in this Mustang chassis harness is a 20amp accessory relay output. The relay is preinstalled in the fuse block, powered, and fused. See Figure 7-30.

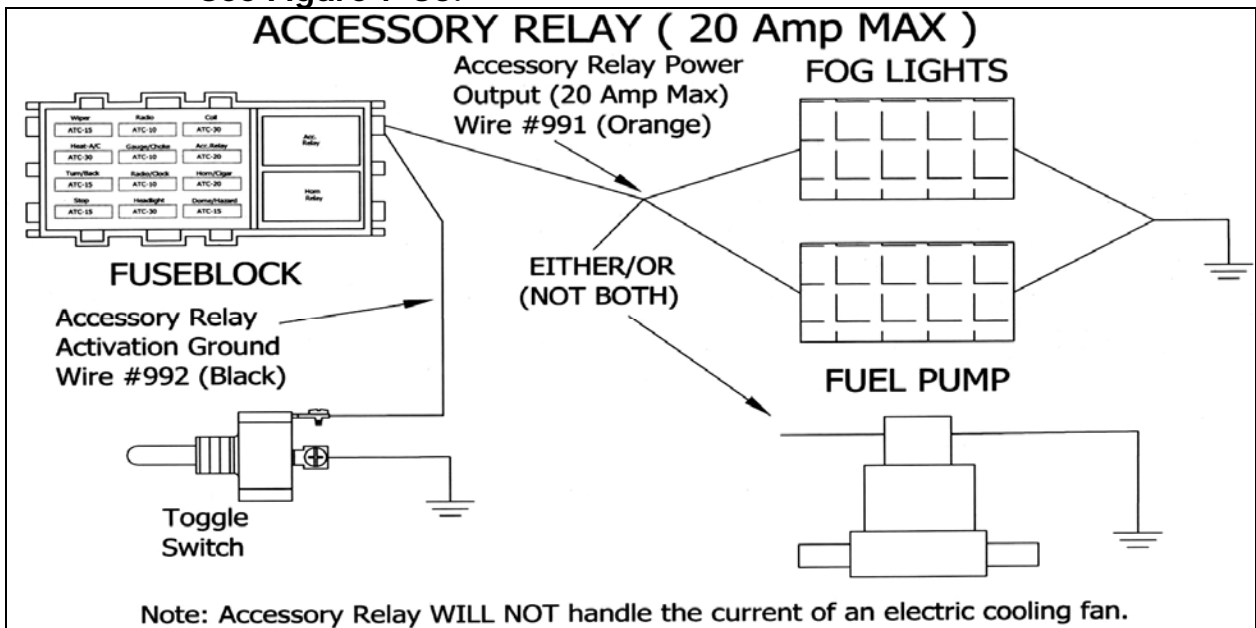

Figure 7-30 Accessory Relay Diagram

8.0 WIRE CONNECTION INDEX AND FUSE REQUIREMENTS

8.1 Wire Connection Index

In each section, connect the wire, as identified by its wire color, to the appropriate item in the Wire Ending Point column.

Table 8.2 is divided into sections that correspond to the sections of your wire harness. (ENGINE SECTION, HEADLIGHT SECTION, GAUGE CLUSTER SECTION, UNDER DASH SECTION, INTERIOR LIGHTING SECTION, AND REAR LIGHT SECTION) The index is divided vertically into six columns. COLOR, GAUGE, NUMBER, WIRE PRINT, WIRE STARTING POINT, and WIRE ENDING POINT.

The information in these columns are for reference to help identify where each wire and what it needs to be connected to. These columns tell where each wire originates, the wire number, its function and which section of the harness the wire is in.

The column labeled NO. contains a 900-series number used to identify the wires in the diagrams in Section 6.0 and 7.0 of this manual.

The wire numbers which occur TWICE in this index indicate the connection of BOTH ENDS or a splice of wires inside the harness. Most wire segments are pre-connected at the WIRE STARTING POINT such as all the wires originating from the fuse panel. The WIRE ENDING POINT is where that wire needs to be connected.

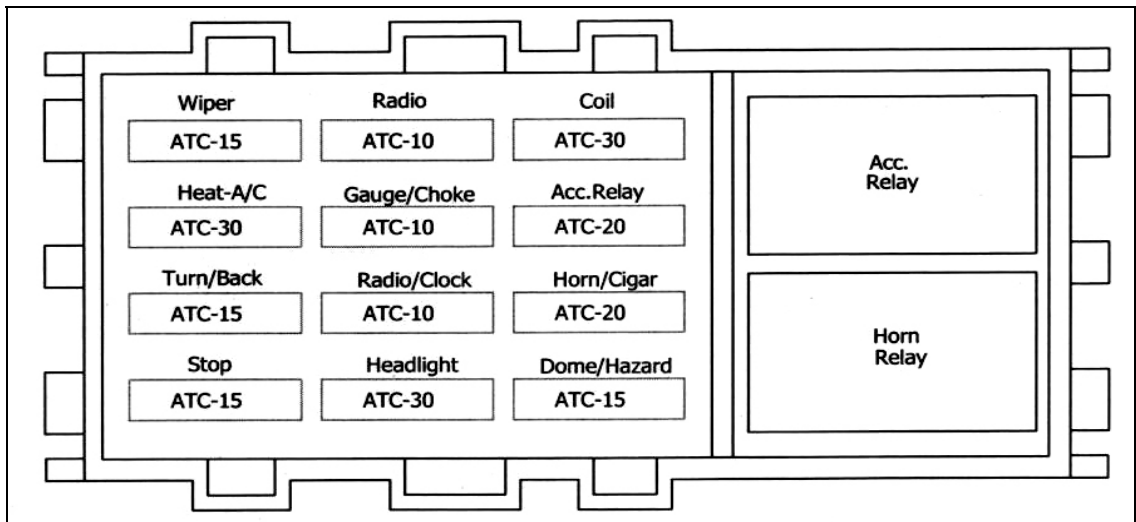

Table 8.1 Fuse Requirements

Color	Gauge	Number	Wire Print	Wire Starting Point	Wire Ending Point
ENGINE SECTION					
Red	18	#954	Electric Choke B+	Fuse Block	Electric Choke
Red/Grn	14	#920	Coil B+	Fuse Block	Coil "+"
Red/Wht	18	#921	Temperature Sending Unit	Gauge Cluster	Temperature Sending Unit
Wht/Red	18	#922	Oil Pressure Sending Unit	Gauge Cluster	Oil Pressure Sending Unit
Brn	16	#970	Ignition Bypass	Starter Solenoid "I" Post	Coil "+"
Red/Ylw	18	#923	Tachometer Signal	Tachometer	Coil "-"
Blk/Red	18	#958	Back-Up Light Switch B+	Fuse Block	Neutral Safety/Back-Up Lights Switch
Blk/Red	18	#956	Back-Up Lights	Back-Up Light Switch	Back-Up Lights
Red/Blu	14	#919	Ignition Switch "Start"	Ignition Switch	Neutral Safety/Back-Up Light Switch
Red/Blu	14	#919	Starter Solenoid	Neutral Safety/Back-Up Light Switch	Starter Solenoid "S" Post
Grn	16	#998	A/C Comp. Clutch Solenoid	A/C Compressor	De-Icing Switch

Table 8.2 Wire Connection Index (1 of 7)

Color	Gauge	Number	Wire Print	Wire Starting Point	Wire Ending Point
HEADLIGHT SECTION					
Brn	16	#970	Ignition Bypass	Coil "+"	Starter Solenoid "I" Post
Red/Blu	14	#919	Starter Solenoid	Neutral Safety/Back-Up Light Switch	Starter Solenoid "S" Post
Blk/Ylw	10	#916	Battery Source (Maxi Fuse)	Fuse Block	Starter Solenoid B+
Wht	14	#914	Alternator Exciter	Voltage Regulator	Alternator "FLD" Post
Blk/Ylw	10	#915	Alternator Output	Fuse Block	Alternator Output Post
Blu/Ylw	16	#924	Horn B+	Horn Relay	Left and Right Horns
Grn/Wht	18	#926	Left Front Turn Signal	Turn Signal Switch	Left Front Turn Signal
Wht/Blu	18	#925	Right Front Turn Signal	Turn Signal Switch	Right Front Turn Signal
Blk/Ylw	18	#927	Park Lights	Headlight Switch	Front Park Lights
Red/Blk	14	#909	Low Beam	Dimmer Switch	Low Beam Headlights
Grn/Blk	14	#908	High Beam	Dimmer Switch	High Beam Headlights
Pur	18	#968	Brake Warning	Brake Light	Proportioning Valve
Grn	16	#983	Washer B+	Wiper Switch	Washer Motor
Dimmer Switch					
Grn/Blk	14	#908	Dimmer Switch (High Beam)	High Beams	Dimmer Switch
Red/Blk	14	#909	Dimmer Switch (Low Beam)	Low Beams	Dimmer Switch
Red/Ylw	14	#907	Dimmer Switch B+	Headlight Switch	Dimmer Switch "Center Spade"

Table 8.2 Wire Connection Index (2 of 7)

Color	Gauge	Number	Wire Print	Wire Starting Point	Wire Ending Point
Headlight Switch					
Blk/Orn	12	#928	Headlight Switch B+	Fuse Block	Headlight Switch Terminal "B"
Blu/Red	16	#930	Instrument Panel Lighting	Gauges, Console, Radio, and Tach Lights	Headlight Switch Terminal "I"
Red/Ylw	14	#907	Dimmer Switch B+	Dimmer Switch	Headlight Switch Terminal "H"
Blk/Ylw	16	#927	Park Lights	Park Lights	Headlight Switch Terminal "P"
Blk	14	#929	Tail Lights	Tail Lights	Headlight Switch Terminal "R"
Grn/Ylw	18	#959	Dome B+ to Headlight Switch (D1)	Fuse Block	Headlight Switch Terminal (D1)
Blk/Blu	18	#959	Dome B+ to Headlight Switch (D2)	Dome and Trunk Lights	Headlight Switch Terminal (D2)
Turn Signal Switch					
Grn/Orn	14	#949	Left Rear Turn Signal	Left Rear Turn/Stop Light	Turn Signal Switch
Wht/Red	16	#951	Emergency Flasher Switch B+	Emergency Flasher	Turn Signal Switch
Lt. Blu	14	#952	Turn Signal Flasher Switch B+	Turn Signal Flasher	Turn Signal Switch
Lt. Grn	14	#918	Brake Switch Output	Brake Switch	Turn Signal Switch
Lt. Grn/Wht	18	#926	Left Front Turn Signal	Left Front Turn Signal	Turn Signal Switch
Wht/Blu	18	#925	Right Front Turn Signal	Right Front Turn Signal	Turn Signal Switch
Orn/Blu	14	#948	Right Rear Turn Signal	Right Rear Turn/Stop Light	Turn Signal Switch
Blu/Ylw	18	#963	To Horn Switch	Horn Relay	Turn Signal Switch
Ylw	18		Horn Switch Ground	Chassis Ground	Turn Signal Switch
Brake Switch					
Grn/Red	14	#917	Brake Switch B+	Fuse Block	Brake Switch
Grn	14	#918	Brake Switch Output	Turn Signal Switch	Brake Switch

Table 8.2 Wire Connection Index (3 of 7)

Color	Gauge	Number	Wire Print	Wire Starting Point	Wire Ending Point
GAUGE SECTION					
Wht/Red	18	#922	Oil Pressure Sending Unit	Oil Sending Unit	Gauge Cluster
Grn/Blk	18	#936	High Beam Indicator	Dimmer Switch	Gauge Cluster
Blk/Grn	18	#935	Voltmeter Source & Gauges B+	Constant Voltage Unit	Gauge Cluster
Blk	18	#969	Dash Ground	Interior Ground	Gauge Cluster
Ylw/Wht	18	#939	Fuel Sending Unit	Fuel Sending Unit	Gauge Cluster
Blk/Grn	18	#935	Voltmeter Source & Gauges B+)	Fuse Block	Gauge Cluster
Blu/Red	18	#930	Cluster Lighting	Headlight Switch	Gauge Cluster
Ylw	18	#972	Ammeter Loop	Fuse Block	Gauge Cluster
Red	18	#972	Ammeter Loop	Starter Solenoid	Gauge Cluster
Wht/Blu	18	#938	Right Turn Indicator	Turn Signal Switch	Gauge Cluster
Red/Wht	18	#921	Temperature Sending Unit	Temperature Sending Unit	Gauge Cluster
Pur	18	#968	Brake Warning	Brake Warn Switch	Gauge Cluster
Red/Ylw	18	#935	Voltmeter Source & Gauges B+)	Fuse Block	Gauge Cluster
Ylw/Blk	18	#935	Voltmeter Source & Gauges B+)	Fuse Block	Gauge Cluster
Grn/Wht	18	#937	Left Turn Indicator	Turn Signal Switch	Gauge Cluster
Red/Grn	14	#920	Coil B+	Fuse Block	Coil
Blu/Red	18	#930	Tachometer Light B+	Headlight Switch	Aftermarket Tach
Red/Ylw	18	#923	Aftermarket Tachometer Signal	Coil	Aftermarket Tach.
Ignition Switch Connections					
Ylw	12	#934	Ignition Switch B+	Maxi Fuse	Ignition Switch
Blk/Grn	14	#932	Ignition Switch Accessory	Fuse Block	Ignition Switch
Grn/Red	12	#933	Ignition Switched Ignition	Fuse Block	Ignition Switch
Red/Blu	14	#919	Starter Solenoid	Neutral Safety/Back-Up Light Switch	Ignition Switch
Pur	18	#968	Brake Warning	Brake Warn Switch	Ignition Switch
Blk/Ylw	18	#930	Ign. Switch Light	Headlight Switch	Ignition Switch

Table 8.2 Wire Connection Index (4 of 7)

Color	Gauge	Number	Wire Print	Wire Starting Point	Wire Ending Point
Wiper Switch					
Orn/Wht	16	#982	Wiper Motor B+	Fuse Block	Wiper Switch
Blu	16	#977	To Wiper Switch/To Wiper Motor (HIGH)	Wiper Motor	Wiper Switch
Wht	16	#979	To Wiper Switch (Low)	Wiper Motor	Wiper Switch
Red	16	#982	Wiper Motor B+	Fuse Block	Wiper Switch
Blk	16	#981	Wiper Motor Park	Wiper Motor	Wiper Switch
Grn	16	#983	Washer B+	Washer Motor	Wiper Switch
Wht/Blk	16	#905	Wiper Switch B+	Fuse Block	Wiper Switch
Wiper Motor					
Blu	16	#977	To Wiper Switch/To Wiper Motor (HIGH)	Wiper Switch	Wiper Motor
Wht	16	#979	To Wiper Switch (Low)	Wiper Switch	Wiper Motor
Red	16	#982	Wiper Motor B+	Wiper Switch	Wiper Motor
Blk	16	#981	Wiper Motor Park	Wiper Switch	Wiper Motor
Blower Motor					
Blk/Ylw	14	#973	Blower Motor (High)	Heat-A/C Switch	Blower Motor
Blu	14	#974	Blower Motor (Med)	Heat-A/C Switch	Blower Motor
Red	14	#975	Blower Motor (Low)	Heat-A/C Switch	Blower Motor
Blower Motor Switch					
Blk/Ylw	14	#973	Blower Motor (High)	Blower Motor	Heat-A/C Switch
Blu	14	#974	Blower Motor (Med)	Blower Motor	Heat-A/C Switch
Red	14	#975	Blower Motor (Low)	Blower Motor	Heat-A/C Switch
Lt. Grn	18	#994	A/C Mode Switch / De-Ice Switch	De-Ice Switch	A/C Mode Switch
De-Icing Switch					
Lt. Grn	18	#994	A/C Mode Switch / De-Ice Switch	A/C Mode Switch	De-Icing Switch
Grn	16	#998	A/C Comp. Clutch Solenoid	A/C Compressor	De-Icing Switch
Interior Lighting Section					
Blu/Red	18	#930	Gear Ind. Light B+	Headlight Switch	Gear Indicator Light
Blk/Wht	18	-	Gear Ind. Light Ground	Interior Ground	Gear Indicator Light
Blu/Red	18	#930	Console Light B+	Headlight Switch	Console Light

Table 8.2 Wire Connection Index (5 of 7)

Color	Gauge	Number	Wire Print	Wire Starting Point	Wire Ending Point
INTERIOR LIGHTING SECTION (CONT.)					
Blk/Wht	18	-	Console Light Ground	Interior Ground	Console Light
Grn/Ylw	18	#900	Map Light B+	Fuse Block	Map Light
Blk/Wht	18	-	Map Light Switch Ground	Interior Ground	Map Light Switch
Blk	18	#990	Glove Box Light Switch	Map Light Switch	Glove Box Light Switch
Grn/Ylw	18	#988	To Right Door Jamb Switch B+	Fuse Block	Right Door Jamb Switch
Blk/Blu	18	#988	To Right Door Jamb Switch	Interior Lighting Circuit	Right Door Jamb Switch
Blk/Blu	18	#989	Right Courtesy Light	Right Door Jamb Switch	Right Courtesy Light
Blk/Blu	18	#989	Right C Pillar Light B+	Interior Lighting Circuit	Right C Pillar Light
Blk/Wht	18	-	Right C Pillar Light Ground	Interior Ground	Right C Pillar Light
Blk/Blu	18	#989	Right Door Light B+	Interior Lighting Circuit	Right Door Light
Blk/Wht	18	-	Right Door Light Ground	Interior Ground	Right Door Light
Grn/Ylw	18	#987	To Left Door Jamb Switch B+	Fuse Block	Left Door Jamb Switch
Blk/Blu	18	#987	To Left Door Jamb Switch	Interior Lighting Circuit	Left Door Jamb Switch
Blk/Blu	18	#989	Left Courtesy Light	Left Door Jamb Switch	Left Courtesy Light
Blk/Blu	18	#989	Left C Pillar Light B+	Interior Lighting Circuit	Left C Pillar Light
Blk/Wht	18	-	Left C Pillar Light Ground	Interior Ground	Left C Pillar Light
Blk/Blu	18	#989	Left Door Light B+	Interior Lighting Circuit	Left Door Light
Blk/Wht	18	-	Left Door Light Ground	Interior Ground	Left Door Light

Table 8.2 Wire Connection Index (6 of 7)

Color	Gauge	Number	Wire Print	Wire Starting Point	Wire Ending Point
Accessories					
Orn	16	991	Accessory Relay Power Output (20 Amp Max)	Accessory Relay	20 Amp or less Accessory
Blk	18	992	Accessory Relay Activation Ground	Accessory Relay	Ground Activation Switch
Blu/Red	18	930	Radio Light B+	Headlight Switch	Light in Radio
Red	18	940	Constant Radio B+	Fuse Block	Radio
Ylw/Blk	18	941	Switched Radio B+	Fuse Block	Radio
Blu/Wht	18	#903	Cigar. Lighter B+	Fuse Block	Cigar. Lighter
Blk/Wht	18	-	Cigar. Lighter Ground	Interior Ground	Cigar. Lighter
Rear Light Section					
Blk/Blu	18	945	To Dome Light	Headlight Switch/Jamb Switches	Dome Light
Blk/Red	18	956	Left/Right Back-Up Lights	Back-Up Light Switch	Back-Up Lights
Grn/Orn	14	949	Left Rear Turn Signal	Turn Signal Switch	Left Rear Turn/Stop Signal
Orn/Blu	14	948	Right Rear Turn Signal	Turn Signal Switch	Right Rear Turn/Stop Signal
Ylw/Wht	18	939	Fuel Sending Unit	Fuel Gauge	Fuel Sending Unit
Blk	16	929	Left/Right Tail Lights	Headlight Switch	Tail Lights
Blk	18	962	License Plate Light B+	Headlight Switch	License Plate Light
Grn/Ylw	18	946	Trunk Light B+	Headlight Switch	Trunk Light
Brn	18	#929	Left/Right Park Lights	Headlight Switch	Park Lights
Blk/Wht	18	-	Ground(s)	Rear Ground	-

Table 8.2 Wire Connection Index (7 of 7)

Painless Performance Limited Warranty and Return Policy

Chassis harnesses and fuel injection harnesses are covered under a lifetime warranty.

All other products manufactured and/or sold by Painless Performance are warranted to the original purchaser to be free from defects in material and workmanship under normal use. Painless Performance will repair or replace defective products without charge during the first 12 months from the purchase date. No products will be considered for warranty without a copy of the purchase receipt showing the sellers name, address and date of purchase. You must return the product to the dealer you purchased it from to initiate warranty procedures.

NOTES