



Wire Harness Installation Instructions

For Installing:

**Part #20121
14 Circuit
1967 – 1968 Ford Mustang**

Manual #90556



Perfect Performance Products, LLC

Painless Performance Products Division

2501 Ludelle Street

Fort Worth, TX 76105-1036

800-423-9696 phone – 817-244-4024 fax

Web Site: www.painlessperformance.com

E-Mail: painless@painlessperformance.com

If you have any questions concerning the installation of this harness or having trouble in general, feel free to call Painless Performance Products' tech line at 1-800-423-9696. Calls are answered from 8am to 5pm central time, Monday thru Friday, except holidays.

We have attempted to provide you with as accurate instructions as possible, and are always concerned about corrections or improvements that can be made. If you have found any errors or omissions, or if you simply have comments or suggestions concerning these instructions, please write us at the address on the cover and let us know about them. Or, better yet, send us a fax at (817) 244-4024 or e-mail us at painless@painlessperformance.com. We sincerely appreciate your business.

Perfect Performance Products, LLC shall in no event be liable in contract or tort (including negligence) for special, indirect, incidental, or consequential damages, such as but not limited to, loss of property damage, or any other damages, costs or expenses which might be claimed as the result of the use or failure of the goods sold hereby, except only the cost of repair or replacement.

P/N 90556 Painless Wiring Manual

March 29th, 2005

Copyright © 2005 by Perfect Performance Products, LLC

TABLE OF CONTENTS

1.0	Introduction	
2.0	About These Instructions.....	1
3.0	Contents in The Painless Wire Harness Kit.....	2
4.0	Tools Needed.....	2
5.0	Pre-Installation and Harness Routing Guidelines.....	3
6.0	Harness Installation Instructions.....	4
6.1	General Installation	
6.2	Harness Attachment	
6.3	Grounding The Automobile	
6.4	Terminal Installation and Making Connections	
6.5	Testing The System	
7.0	Specific Circuit Connections.....	10
7.1	Alternator/Regulator/Solenoid	
7.2	High Amperage Alternator Kit	
7.3	Engine Section	
7.4	Headlights/Front Turn Signals/Park Lights/Horns	
7.5	Rear Light Section	
7.6	Steering Column Wiring - Turn Signal Connections	
7.7	Ignition Switch Connections	
7.8	Headlight Switch	
7.9	Brake Lights Switch	
7.10	Gauge Cluster Section	
7.11	Heater-A/C Components	
7.12	Wiper Switch/Coordination Switch/Dimmer Switch/Wiper Motor	
7.13	Interior Lighting and Accessories	
8.0	Wire Connection Index and Fuse Requirements.....	23

LIST OF TABLES

Table 8.1	Fuse Requirements.....	23
Table 8.2	Wire Connection Index (1 of 6).....	24
Table 8.2	Wire Connection Index (2 of 6).....	25
Table 8.2	Wire Connection Index (3 of 6).....	26
Table 8.2	Wire Connection Index (4 of 6).....	27
Table 8.2	Wire Connection Index (5 of 6).....	28
Table 8.2	Wire Connection Index (6 of 6).....	29

Painless Performance Products recommends, you the consumer, read this installation manual from front to back before installing this harness. Due to the variables in modifications done to these classic 1967 and 1968 Mustangs, reading this manual will give you considerable insight on the proper installation of this harness in an original or modified application.

1.0 INTRODUCTION

You have purchased what we at Painless Performance Products believe to be the most up-to-date and easiest-to-install automotive wire harness on the market. It is designed for easy installation, even if you have no electrical experience

All Kits have a built-in-anti-theft feature. Removing the fuse labeled "coil" from the fuse block will prevent the vehicle from starting.

The proper fuses have been pre-installed in the fuse block. In addition, all wires are color-coded and marked for easy identification. This will help you identify the different circuits during installation and later on if additions to the overall system are necessary. For fuse specifications and wire color designations, see **Section 8.1 and Table 8.1**.

This Painless wire harness is designed to be used in 1967 - 1968 Ford Mustangs. All wire is 600 volt, 257°F, TXL. Standard automotive wire is GPT, 300 volt, 176°F, with PVC insulation.

This complete Classic Mustang wiring system has been designed with six major sections incorporated into it:

ENGINE SECTION: Water temperature, oil pressure, tachometer, coil, choke, a/c compressor clutch coil

HEADLIGHT SECTION: Includes high beam, low beam, park lights, right turn, left turn, horns, voltage regulator, starter solenoid, battery feed and alternator.

GAUGE CLUSTER SECTION: Includes wires to connect to the gauges and to the indicator lights.

UNDER-DASH SECTION: Includes wires to connect heater-a/c switch, headlight switch, turn signal switch, radio, tachometer, ignition switch, cigar lighter, dimmer switch, brake switch, heater-a/c resistor, a/c blower motor, wiper motor, wiper switch and wiper coordination switch.

INTERIOR LIGHTING SECTION: Includes right and left door jam switches, shift indicator light, courtesy lights, and glove box.

REAR LIGHT SECTION: Includes taillights, stoplights, left and right turn signals, trunk light, backup lights, license plate light, and fuel sending unit.

2.0 ABOUT THESE INSTRUCTIONS

The contents of these instructions are divided into major **Sections**, as follows:

- 1.0 Introduction
- 2.0 About These Instructions
- 3.0 Contents of Painless Wire Harness Kit
- 4.0 Tools Needed
- 5.0 Pre-Installation and Harness Routing Guidelines
- 6.0 Harness Installation Instructions
- 7.0 Specific Circuit Connections
- 8.0 Wire Connection Index and Fuse Requirements

Sections are divided into subsections and **Paragraphs**. Throughout these instructions, the **Figure** numbers refer to illustrations and the **Table** numbers refer to information in table form. These are located in Sections or Paragraphs corresponding to the number. Always pay special and careful attention to any *Notes*, especially those in the Tables, and any text marked **Caution**.

3.0 CONTENTS OF THE PAINLESS WIRE HARNESS KIT

Refer to the list below to take inventory of all the parts in the kit. If anything is found to be missing, contact the dealer the kit was purchased from or Painless Performance at (800)423-9696. The 1967/1968 Mustang Wire Harness Kit should contain the following items:

- The Main Wire Harness, with Fuse Block pre-wired fuses and relays installed.
- Pig Tails: Headlight Connector Harnesses, A/C Harness, Cluster Harness, Front Lights Ground Harnesses, Tail Ground Harness and 1968 Turn Signal Harness.
- Bag Kit: 1 pkg. of small and 1 pkg. of large Nylon Tie Wraps, Ballast Resistor, Maxi Fuse, Firewall Grommets, 1968 Ignition Switch and a Fuse Identification Label.
- Parts Box containing Terminals, Splices, Spare Fuses etc.



Figure 3-1 Painless Wire Harness Kit

4.0 TOOLS NEEDED

In addition to basic hand tools the following will also be needed:

- Crimping Tool *Note: Use a quality tool to avoid over-crimping.*
- Wire Stripper
- Test Light or Volt Meter
- Small (10 amp or less) Battery Charger

5.0 PRE-INSTALLATION AND HARNESS ROUTING GUIDELINES

Installation of this wire harness consists mainly of two parts:

- The physical routing and securing of the wire harness.
- The connection of the individual circuits to their components.

These two major tasks are not separate steps, but are integrated together. In other words, you will route a section of wires and make that sections connections. Route the next section of wires and make those sections connections. The layout of this 1967-1968 Mustang harness will dictate how to physically route the harness in your automobile. The breakouts and connections are very close to the original Ford harnesses and should fit just as well if not better. It's a good idea to document how the original harness was routed as this new one follows most of the same routing. The fitment greatly depends on to what extent you want to secure and conceal the harness. Painless offers some general guidelines and routing practices starting in **Section 5.2**, GENERAL installation instructions in **Section 6.0**, and precise instructions concerning the electrical connections you will make in **Section 7.0**. To help you begin thinking through the installation of your wire harness please read the following sections:

- 5.1** Familiarize yourself with the harness by removing the harness from the box, laying it out on a table or on the floor and locating each of the harness sections in the following list. Whenever a particular harness section is referred to in these instructions it is shown in "all caps": ENGINE SECTION.

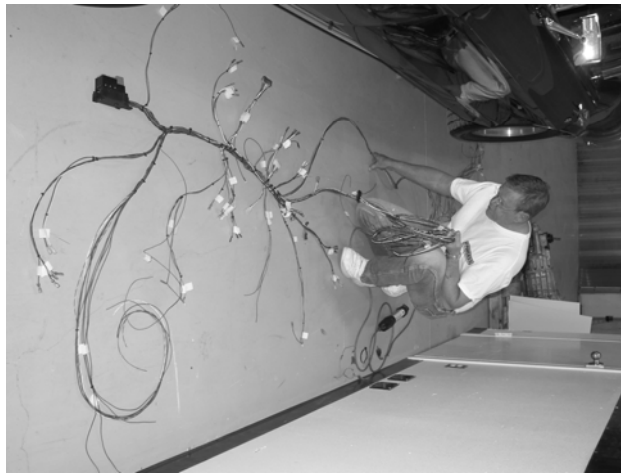

ENGINE SECTION
HEADLIGHT SECTION
GAUGE CLUSTER SECTION
UNDER-DASH SECTION
INTERIOR LIGHTING SECTION
REAR LIGHT SECTION

- 5.2** It is recommended to route the harness through and around open areas inside the car. Inside edges provide protection from hazards and also provide places for tie wraps, clips, and other support.
- 5.3** Route the harness away from sharp edges, exhaust pipes, hood, trunk and door hinges.
- 5.4** Plan where harness supports will be located. Allow enough slack at places where movement could occur (body to frame, frame to engine, etc.)
- 5.5** At wire ends, don't depend on the terminals to support the harness. The weight of the harness could cause terminals to disconnect or copper wire strands to break.
- 5.6** The wires should be bundled into groups. Use nylon ties, poly split loom, or tape.

6.0 HARNESS INSTALLATION INSTRUCTIONS

6.1 General Installation

CAUTION: *DISCONNECT THE POWER FROM YOUR VEHICLE BY REMOVING THE NEGATIVE (BLACK) BATTERY CABLE FROM THE BATTERY.*

Note: Be sure to retain Convertible Power Top wiring and Overhead Console wiring when removing the old harness. Circuits for these accessories are not included in this harness.

- 6.1.1** Mount the base in the stock fuse block location with two of the self tapping screws from the parts kit. **See Figure 6-1.**

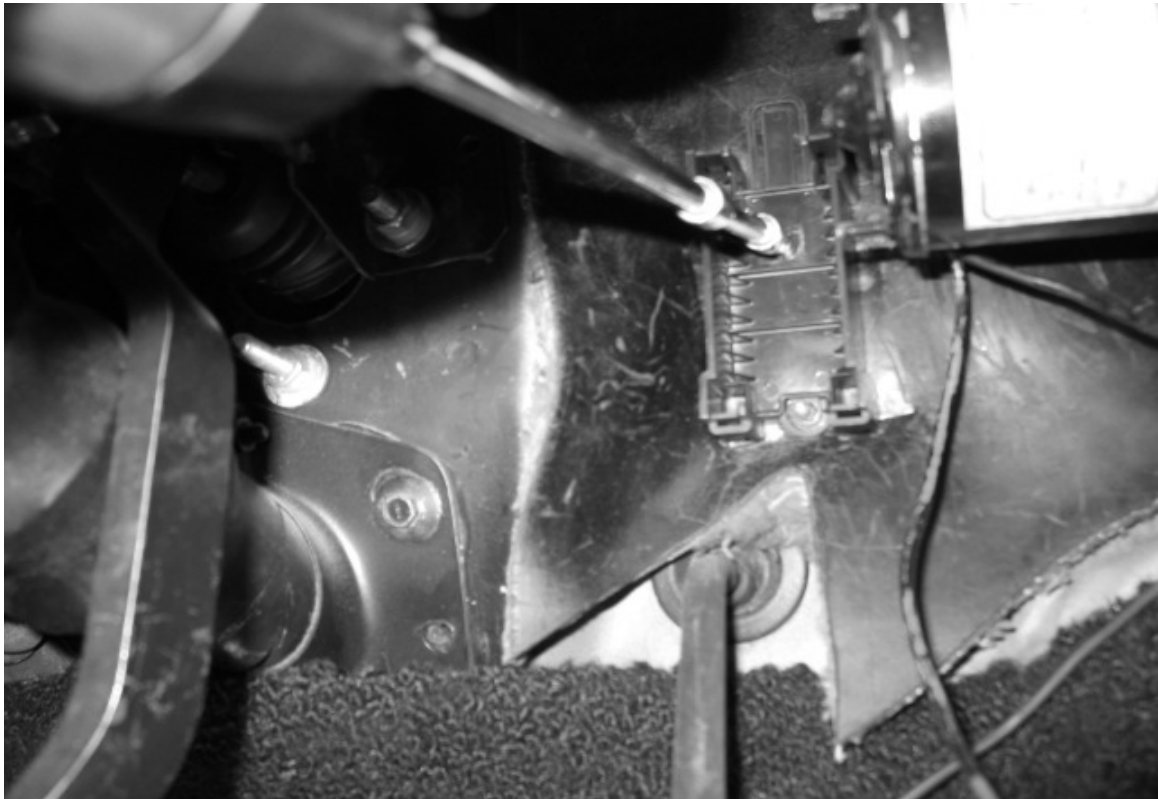

Figure 6-1 Fuse Block Base Position



Figure 6-3 Routing Fuse Block through Instrument Cluster Opening

- 6.1.2** Route the fuse block and attached harness through the instrument cluster opening, down past the wiper motor and snap it into the fuse block base. **See Figure 6-3 and Figure 6-4.** (Note: The fuse block does **not** need to be grounded.)

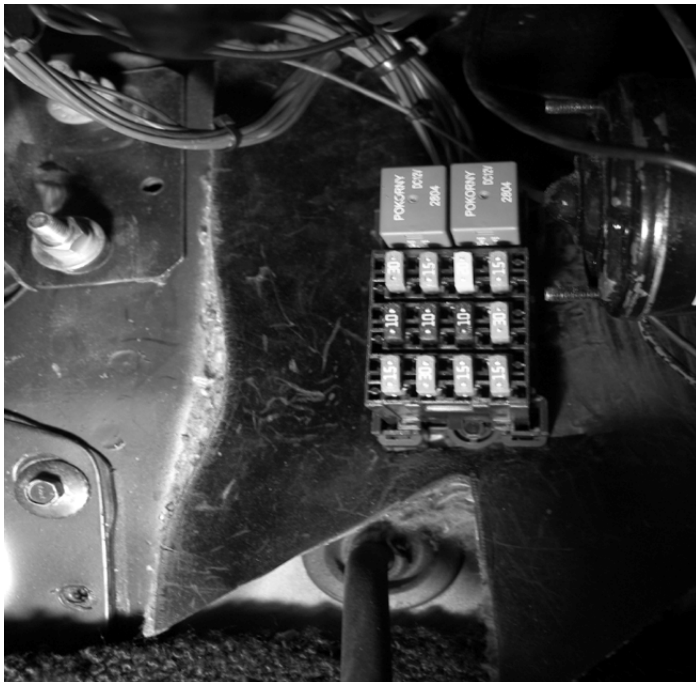

Figure 6-4 Fuse Block Snapped Into Base

- 6.1.3** Route the harness across the cluster opening from right to left, down through the opening under the headlight switch and to the floor pan. Carefully remove any extra slack in the harness. Reuse the clamp which held the original harness to the dash.

6.1.4 Locate the smaller of the two grommets included in the parts kit. Install this grommet into the hole which is directly to the left of the brake master cylinder when facing the firewall. Locate and gently pull the ENGINE SECTION wires through the firewall. **See Figure 6-5.**



Figure 6-5 Engine Section Firewall Grommet

6.1.5 Now locate the **Rear Light Section** of the harness. This section of the harness will be routed down through the A-pillar; through the sill plate, through the B-pillar, over the driver's side quarter panel wheel well and into the trunk. **See Figures 6-6 thru 6-9. Note: In figure 6-8 the original harness is being taped to the new harness to aid in pulling the Rear Light Section through the quarter panel and into the trunk.**



Figure 6-6



Figure 6-7



Figure 6-8



Figure 6-9

6.1.6 The final main section of the harness to be pulled is the **Headlight Section**. This section of the harness is to be fed through the hole in the firewall which is directly to the right of the master cylinder. After this section has been pulled through, carefully install the large grommet from the parts kit into the hole. See **Figures 6-10 and 6-11**.

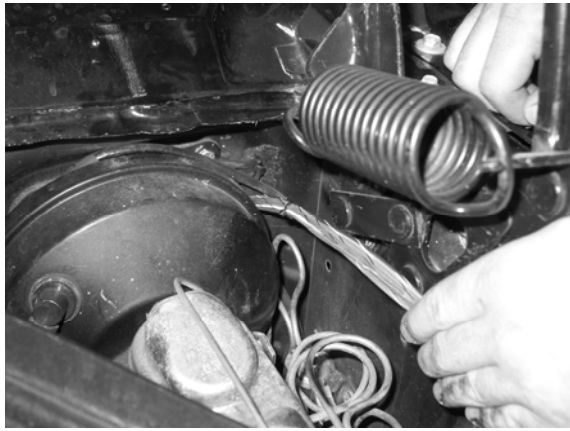

Figure 6-10

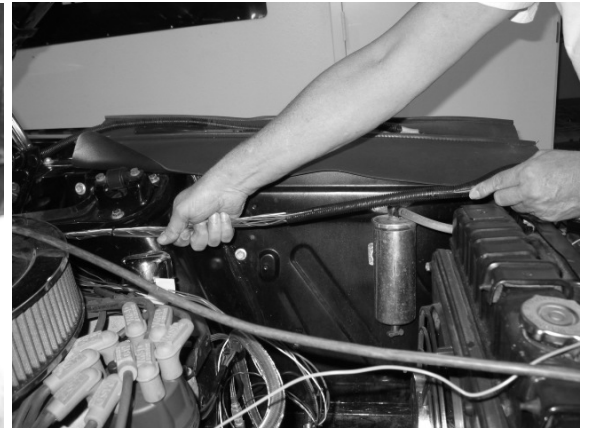

Figure 6-11

6.1.7 Attach the harness to the shock tower using the provided zip ties or using the original clamps. Route it through the radiator core support holes and across the front of the car. **Note: This new harness is designed to be routed in the stock harness location. See Figures 6-12 thru 6-15.**



Figure 6-12 Below Voltage Reg.



Figure 6-13 Front Core Support



Figure 6-14 Pass. Side Core Support



Figure 6-15 Pass. Side Core Support

6.2 Harness Attachment

Harness routing and shaping is and should be a time-consuming task. Taking your time will enhance the beauty of your installation. Please be patient and TAKE YOUR TIME!

- 6.2.1 Mold the harness to contour the firewall, fenders, core support or any other areas where wires or harness sections are routed. Remember to route the harness away from sharp edges, exhaust pipes, hood, trunk, and door hinges.
- 6.2.2 Attach harness groups to your automobile with clips or zip ties starting at the fuse block and working your way towards the outer harness circuits. The dash wires should be routed out of the way of any under-dash obstacles, such as vent levers, air conditioning controls, radio, etc.

Note: Do not tighten tie wraps and mounting devices until each individual connection has been made on the particular circuit to be wire tied. Make all harness attachments LOOSELY, until all connections are made in each section.

- 6.2.3 When using wire loom on the visible areas of the harness, it will need to be wire tied every 12" or so. This will make a very attractive assembly. Under the dash a tie installed every 6" or so will hold the wires in place nicely. Remember to take your time.

6.3 Grounding the Automobile

This Painless Wire Harness Kit includes the following ground wires: two front lights ground harnesses, one tail ground harness, one built-in ground wire for the horn, one ground wire on the cluster harness and a ground wire for the accessory relay. Any additional circuits or accessories requiring a ground will have to be added.

- 6.3.1 Connect a Ground Strap or Cable (even a 10-gauge wire is too small) from the Negative Battery terminal to the automobile frame.
- 6.3.2 Connect a Ground Strap from the Engine to the frame. **DO NOT RELY UPON THE MOTOR MOUNTS TO MAKE THIS CONNECTION.**
- 6.3.3 Connect a Ground Strap from the Engine to the Body.

6.4 Terminal Installation and Making Connections

*Note: In the following steps you will be making the circuit connections. Before you start, you should carefully read **Sections 7.0**, as appropriate, and refer to **Section 8.0** as needed, **DOUBLE-CHECKING** your routing and length calculations before cutting any wires and making connections. The majority of the harness has been pre-terminated.*

- 6.4.1 Have all needed tools and connectors handy.
- 6.4.2 Select the correct size terminal for the wire application.
- 6.4.3 Determine the correct wire length and cut the wire. Remember to allow enough slack in the harness and wires at places where movement could possibly occur, such as automobile body to frame, frame to engine, etc. **Double-check your calculations.**

- 6.4.4 Strip the insulation from the wire. Strip only enough necessary for the type of terminal you are using. All of the terminals included in this kit require a ¼" strip length.
- 6.4.5 Insert the stripped portion of the wire into the crimp side of the terminal. Be careful as to not allow the individual wire strands to fray during insertion.
- 6.4.6 Crimp the terminal onto the wire using the proper jaw location on the crimpers.
- Note: In step 6.4.6 be sure to use the proper jaw location on your crimpers. Most crimping tools have it color coded for which cavity to use. 18-22ga – Red, 16-14ga – Blue, and 12-10ga – Yellow. **CAUTION: DO NOT OVER-CRIMP!***
- 6.4.7 Many connections will be made throughout the installation process. Make sure each wire is FIRST properly routed and THEN attach. **DO NOT ATTACH FIRST AND ROUTE AFTERWARD.**
- 6.4.8 After all wires are terminated and securely attached, tighten the mounts and/or zip ties to secure the harness permanently.

6.5 Testing The System

- 6.5.1 Use a small (10 amp or less) battery charger to power up the vehicle for the first time to test the circuits. If there is a problem anywhere, the battery charger's low amperage and internal circuit breaker will provide circuit protection.
- CAUTION: IF YOU HAVE NOT YET DISCONNECTED THE BATTERY FROM THE AUTOMOBILE, DO SO NOW! DO NOT CONNECT THE BATTERY CHARGER WITH THE BATTERY CONNECTED.***
- 6.5.2 Connect the battery charger's NEGATIVE cable to the automobile chassis or engine block and its POSITIVE cable to the automobile's positive battery terminal lug.
- 6.5.3 INDIVIDUALLY turn on each light, ignition, wiper circuit, etc. and check for proper operation.
- Note: The turn signals will not flash properly if you do not have both the front and rear bulbs installed and connected.*
- 6.5.4 After all circuits have been checked, disconnect the battery charger and attach the vehicles battery cables to the battery. REPEAT STEP 6.5.3.

7.0 SPECIFIC CIRCUIT CONNECTIONS

7.1 Alternator/Regulator/Solenoid See Figure 7-1.

- 7.1.1 Connect HEADLIGHT SECTION wire #915 (Blk/Ylw) to the Alternator Output post marked "Bat" or "B+". See Figure 7-2
- 7.1.2 Connect HEADLIGHT SECTION wire #914 (Wht) to the Alternator post marked "FLD". See Figure 7-2
- 7.1.3 Locate the Voltage Regulator Connector in the HEADLIGHT SECTION and plug it in to the Voltage Regulator, which is on the driver's side engine compartment on the core support.
- 7.1.4 Connect the yellow wire with the preinstalled female bullet connector to the Noise Capacitor.
- 7.1.5 Locate the Maxi Fuse Base in the parts kit and attach it to the passenger side shock tower. See Figure 7-3
- 7.1.6 Connect HEADLIGHT SECTION wire #916 to one side of Maxi Fuse Base. Using the remaining portion of wire #916 connect the other side of the Maxi Fuse Base to the Battery side of the starter solenoid. See Figures 7-1, 7-3, & 7-4.

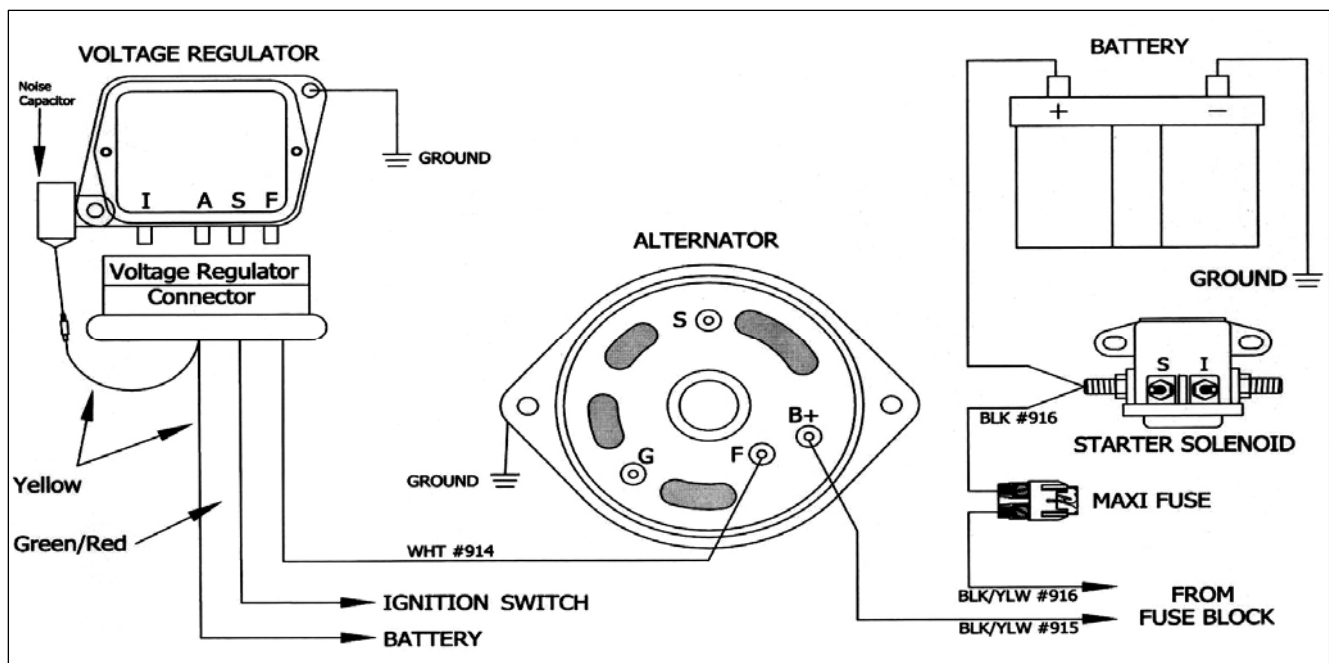

Figure 7-1 Alternator/Regulator/Solenoid Connections

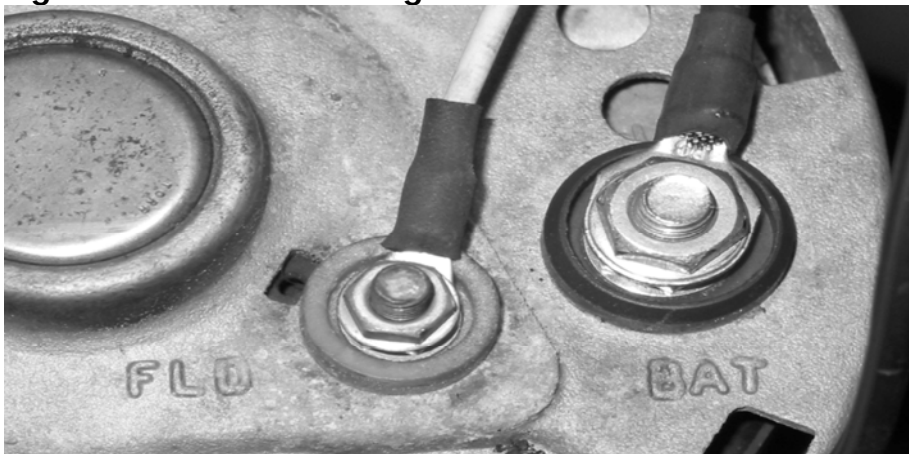

Figure 7-2 Alternator Connections

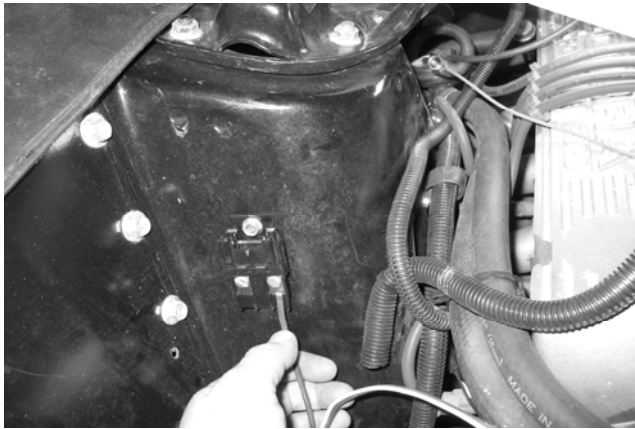

Figure 7-3 R.H. Shock Tower



Figure 7-4 Wire #916 Connection

7.2 High Amperage Alternator Kit

7.2.1 If an alternator with an output of more than 65 amps is being installed, a Painless High Amperage Alternator Kit, **Painless P/N 30709**, will need to be purchased.

7.3 Engine Section See Figure 7-5.

7.3.1 Connect ENGINE SECTION wire #920 to one side of the ballast resistor. Connect the other side of the ballast resistor to the positive post on the ignition coil. *Note: If using a ballast resistor be sure to mount it away from other wiring and hoses. It gets very hot during operation.*

7.3.2 ENGINE SECTION wire #970 is used both on a point's type ignition system and a Duraspark II System. It is to be connected directly to the positive post on the ignition coil or the coil feed side on the ballast resistor. The other end is to be connected to the "I" terminal on the starter solenoid. **See Figure 7-5.**

7.3.3 Connect ENGINE SECTION wire #919 to the "S" terminal on the starter solenoid. If using a Tachometer, connect ENGINE SECTION wire #923 to the negative side of the ignition coil. **See Figure 7-5**

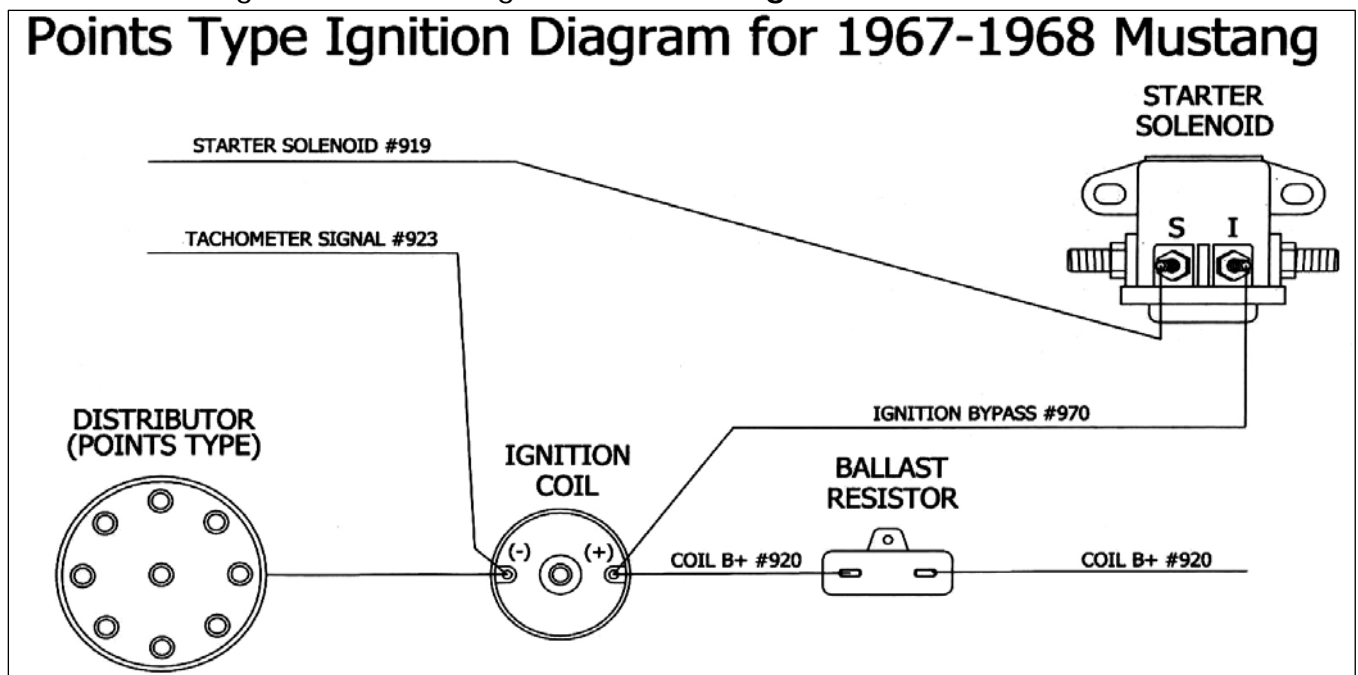

Figure 7-5 Points Type Ignition Diagram

- 7.3.4** Connect ENGINE SECTION Temperature Sending Unit wire #921 to the engine temperature sending unit. Connect ENGINE SECTION Oil Pressure Sending Unit wire #922 to the engine oil pressure sending unit. Connect the ENGINE SECTION Electric Choke B+ wire #954 to the electric choke.

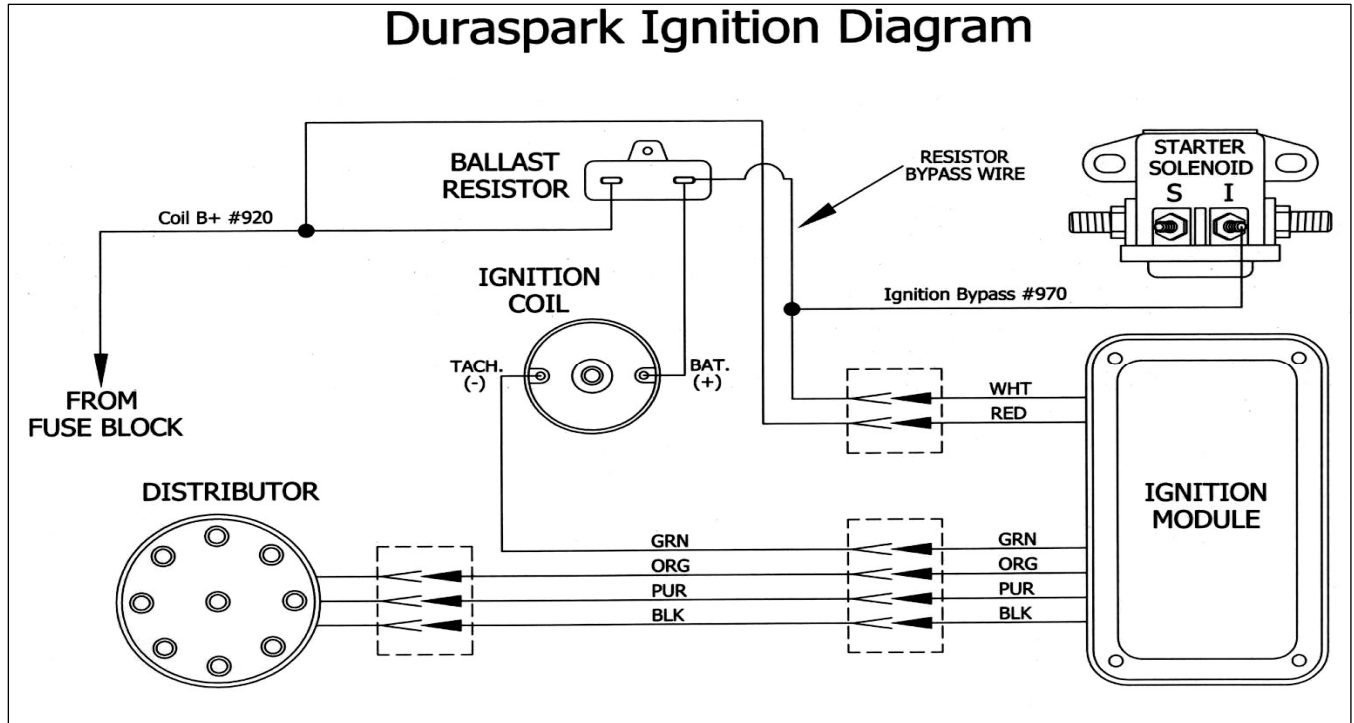

Figure 7-6 Ford Duraspark II Systems (Ford Electronic Ignition)

- 7.3.5** Neutral Safety/Backup Light Switch wire #'s 958, 956 and 919 (2 wires) all breakout from the firewall in the ENGINE SECTION. #958 is the power source to the switch for the backup lights and #956 is the wire connected to the actual bulbs. Wire **IGNITION SWITCH START #919** comes from the start terminal on the Ignition Switch and provides the start signal to the Neutral Safety switch. Wire **STARTER SOLENOID #919** carries the start signal from the Neutral Safety switch to the Starter Solenoid. **See Figure 7-7.**

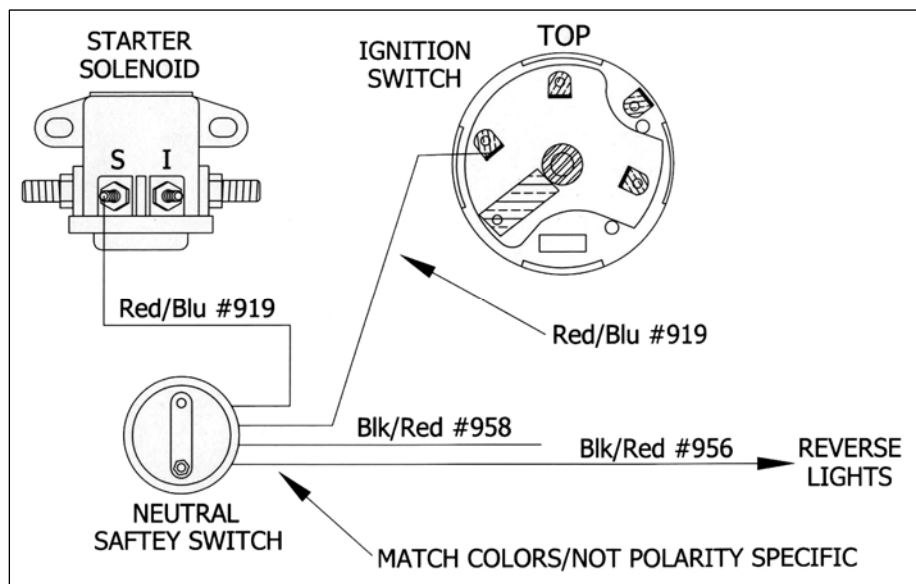

Figure 7-7 NEUTRAL SAFETY SWITCH

7.4 Headlights/Front Turn Signals/Park Lights/Horns

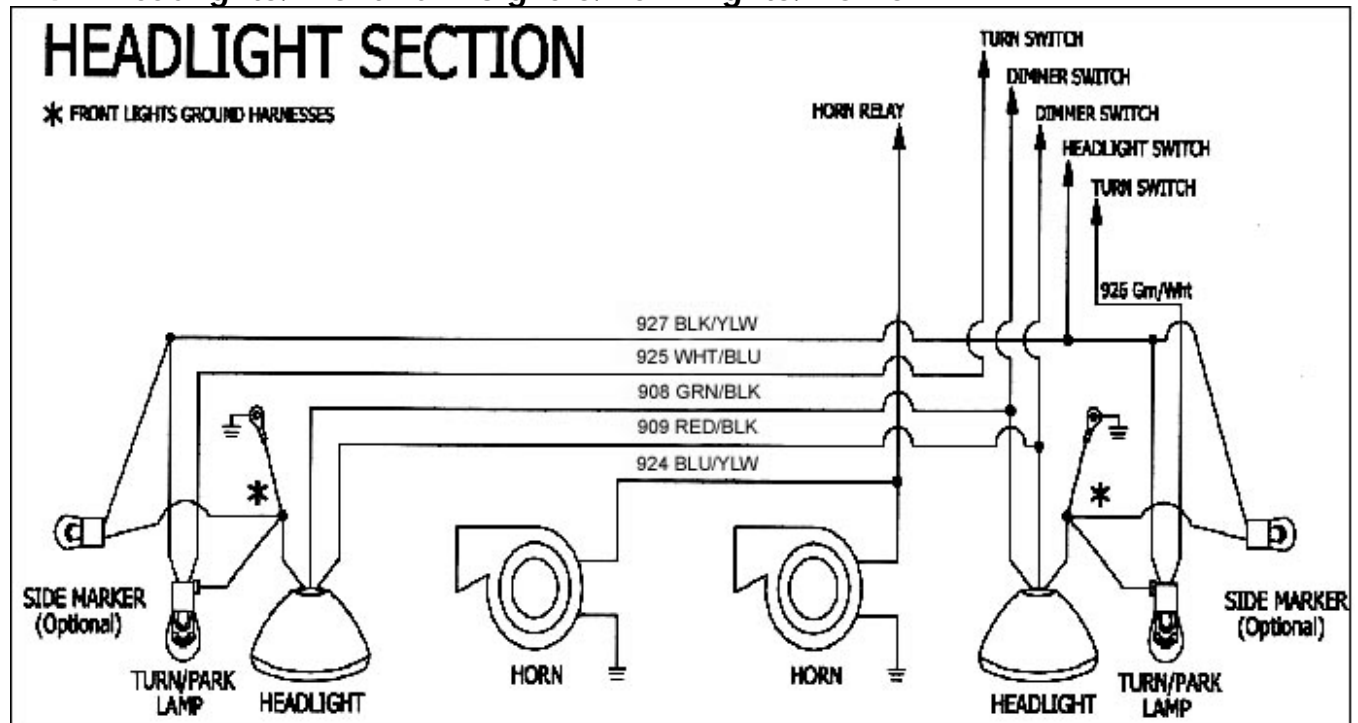

Figure 7-8 Front Lights and Horns

- 7.4.1 Locate the pre-terminated Headlight Pigtails and the Front Lights Ground Harnesses in the parts kit. Install one of the Headlight Pigtails onto each headlight. Feed the wires from each pigtail through the body and core support down to the back of the turn signal housings in each wheel well.
- 7.4.2 *The Front Lights Ground Harness has one 14 gauge wire and two 18 gauge wires. One end of the 14 gauge wire is pre-terminated and will need to be connected to a body bolt. **See Figure 7-9.** The other end of the 14 gauge wire is for the headlights ground. The two 18 gauge wires are to be connected to the Turn/Park Lamps ground and to the Side Marker Lamps ground. **See Figure 7-8.**

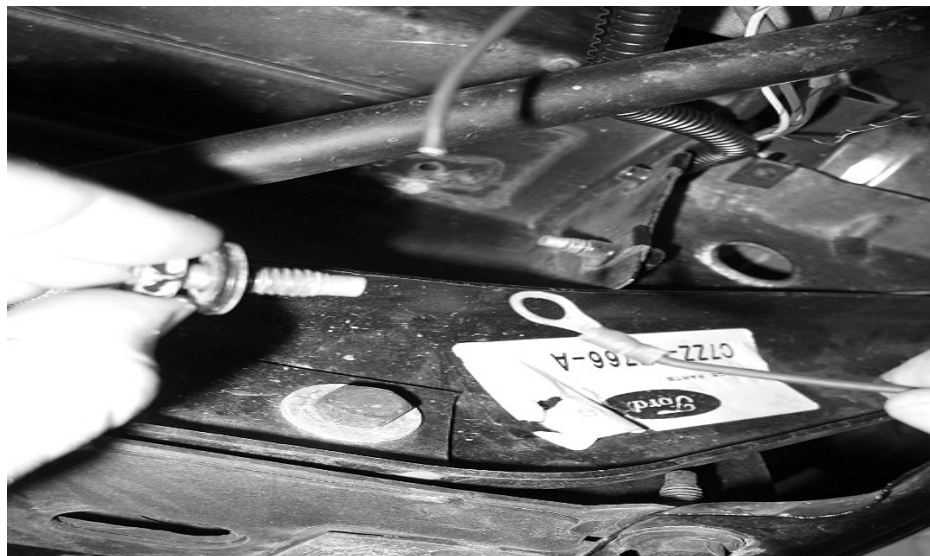

Figure 7-9 Front Lights Ground Harness

Note: Some Mustangs had turn signal indicators on the hood. These lights are supported through this harness by connecting them to the #926 Left Turn Signal wire and the #925 Right Front Turn Signal wire. These wires are located just inside the vehicle past the main grommet on the firewall in the Headlight Section.

7.5 Rear Light Section

7.5.1 The REAR LIGHT SECTION consists of: Taillights, Stoplights, Left and Right Turn Signals, Trunk Light, Backup Lights, License Plate Light, and Fuel Sending Unit.

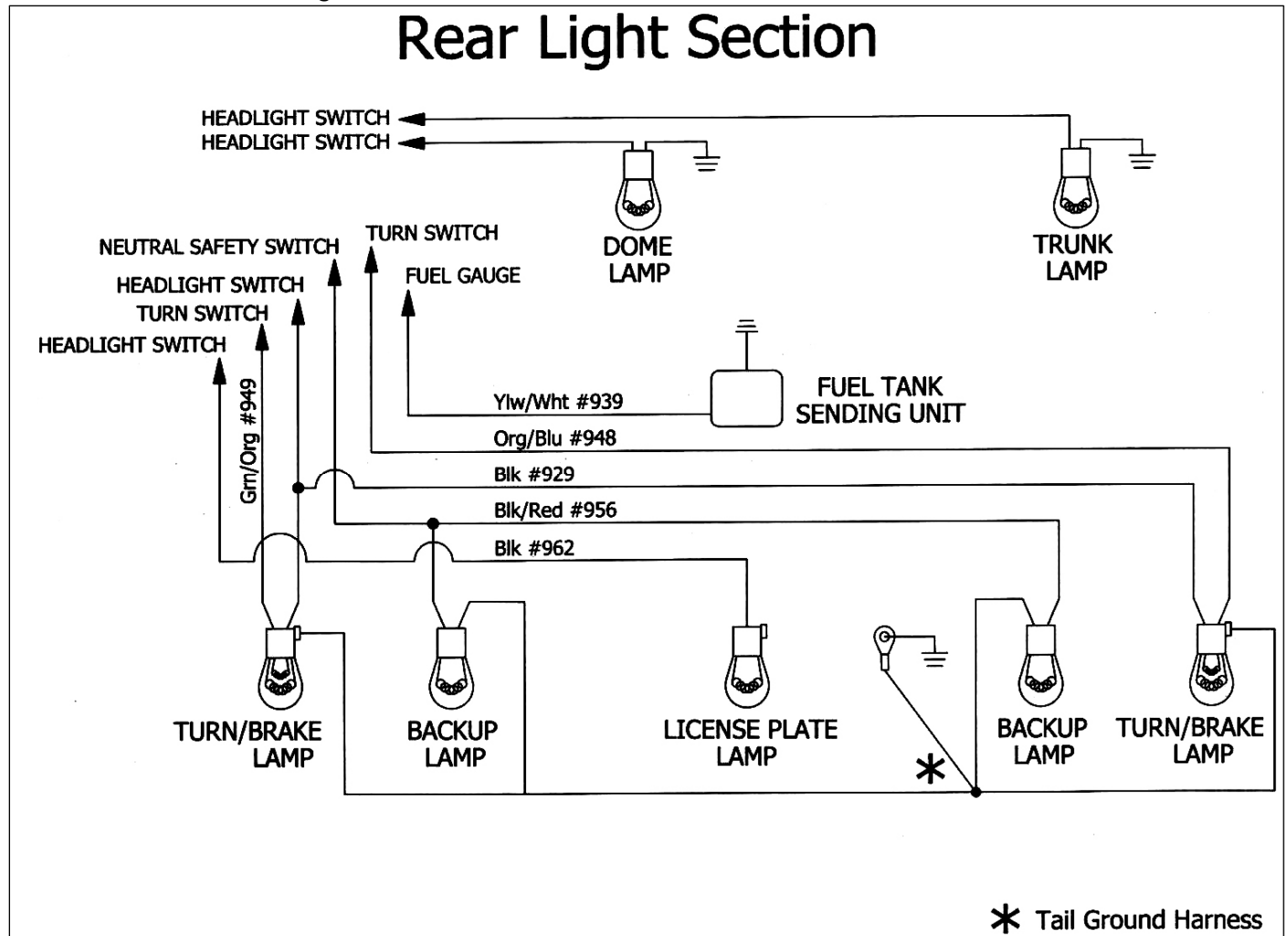

Figure 7-10 Rear Light Section and Dome Light

7.5.2 Locate and connect the Tail Ground Harness as shown in Figure 7-10. The wires in this section are to be routed in the same location as the stock harness. Use the metal tabs under the rear trunk opening lip to secure the harness.

See Figure 7-11.

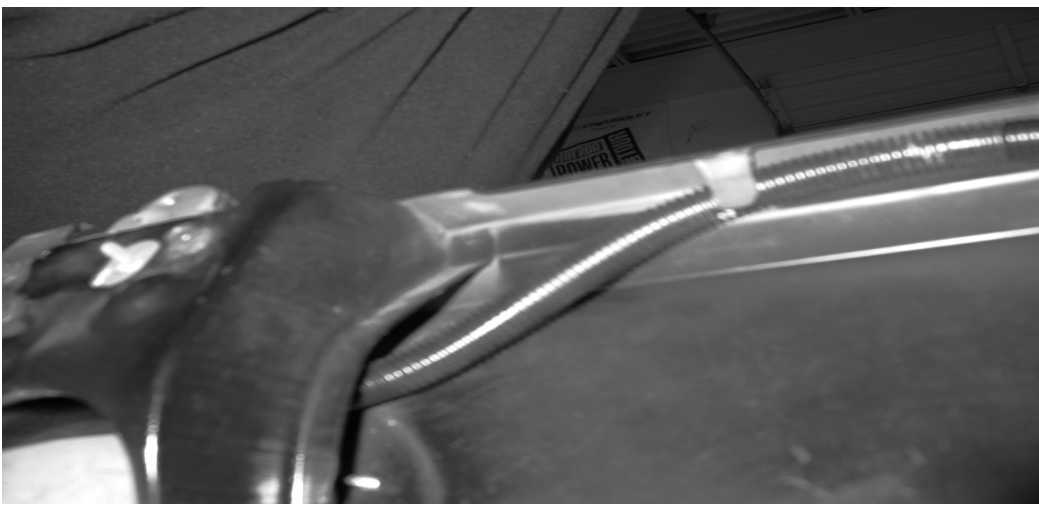

Figure 7-11 Trunk Wiring Tabs

7.6 Steering Column Wiring-Turn Signal Connections

- 7.6.1** If wiring a 1967 Mustang the original Turn Signal Switch Connector will plug directly into the new Painless harness. The only additional connection to be made is to attach the pre-terminated Horn Switch Ground. **See Figure 7-12.**
- 7.6.2** If wiring a 1968 Mustang the original Turn Signal Switch Connector from the old harness will need to be re-used. Carefully remove the original wires, **ONE WIRE AT A TIME, replacing them with the new wires in the 1968 Mustang Turn Signal Adaptor Pigtail. The pigtail colors match the original colors in the old harness.** Use small pair of needle nose pliers or a flat screwdriver to remove the original terminals from the connector cavities. **See Figure 7-12.**

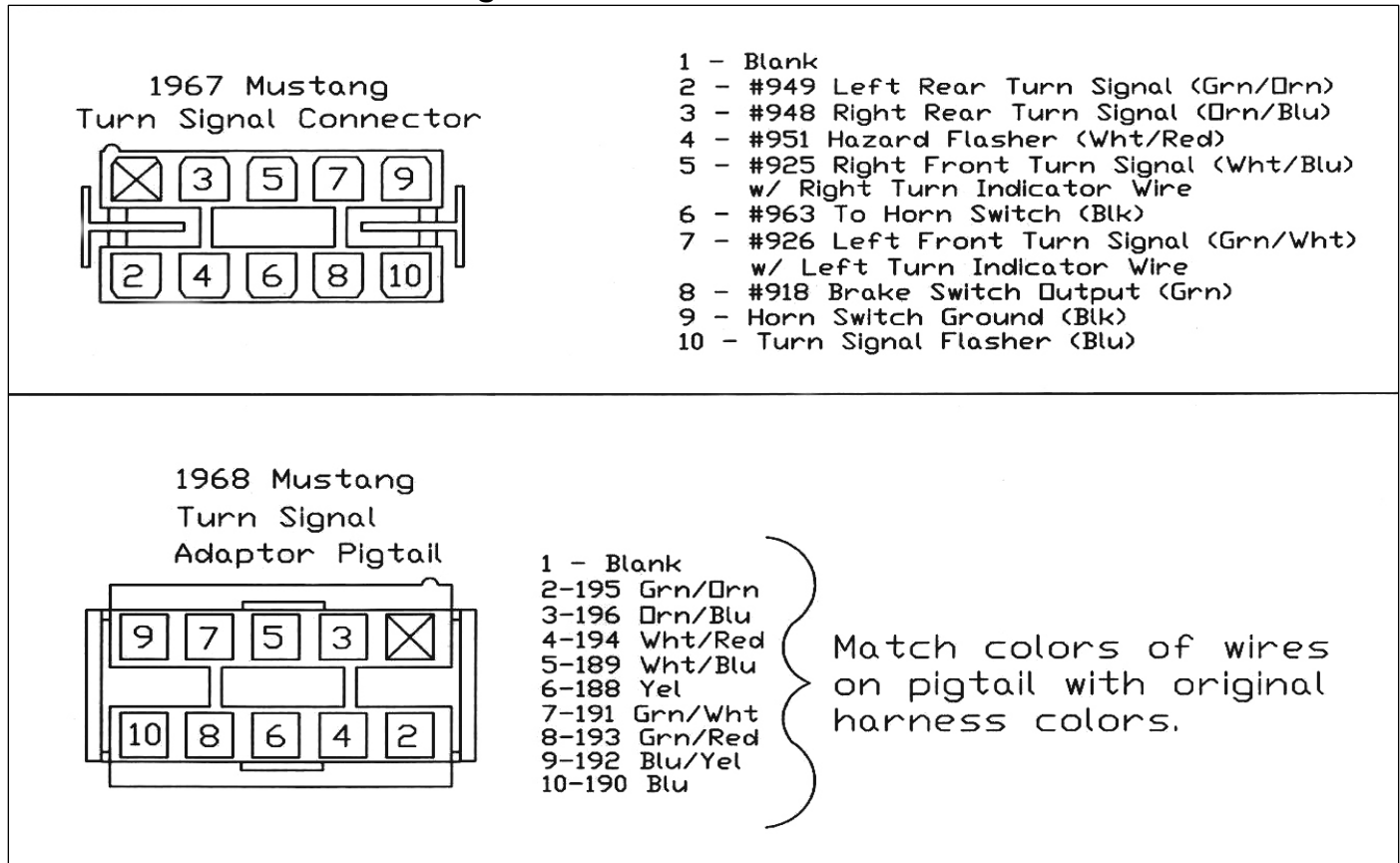

Figure 7-12 Turn Signal Connectors

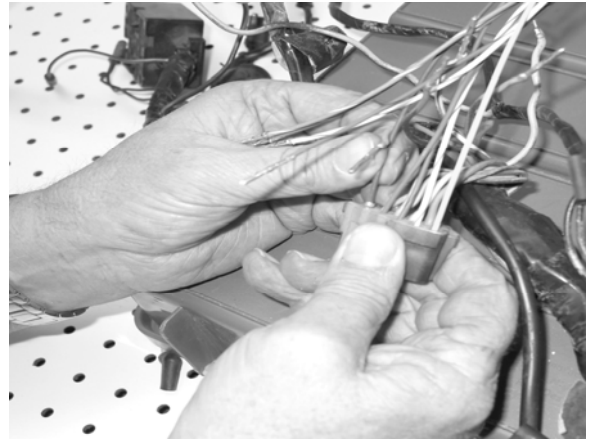

Figure 7-13 Original Turn Signal Connector **Figure 7-14 '68 Adaptor Pigtail Wires**
7.7 Ignition Switch Connections

7.7.1 Connect the IGNITION SWITCH wires to the new supplied Ignition Switch as illustrated in **Figure 7-15**. Use the two 10-24 machine nuts included in the parts kit, to attach the #932 Blk/Grn wire.

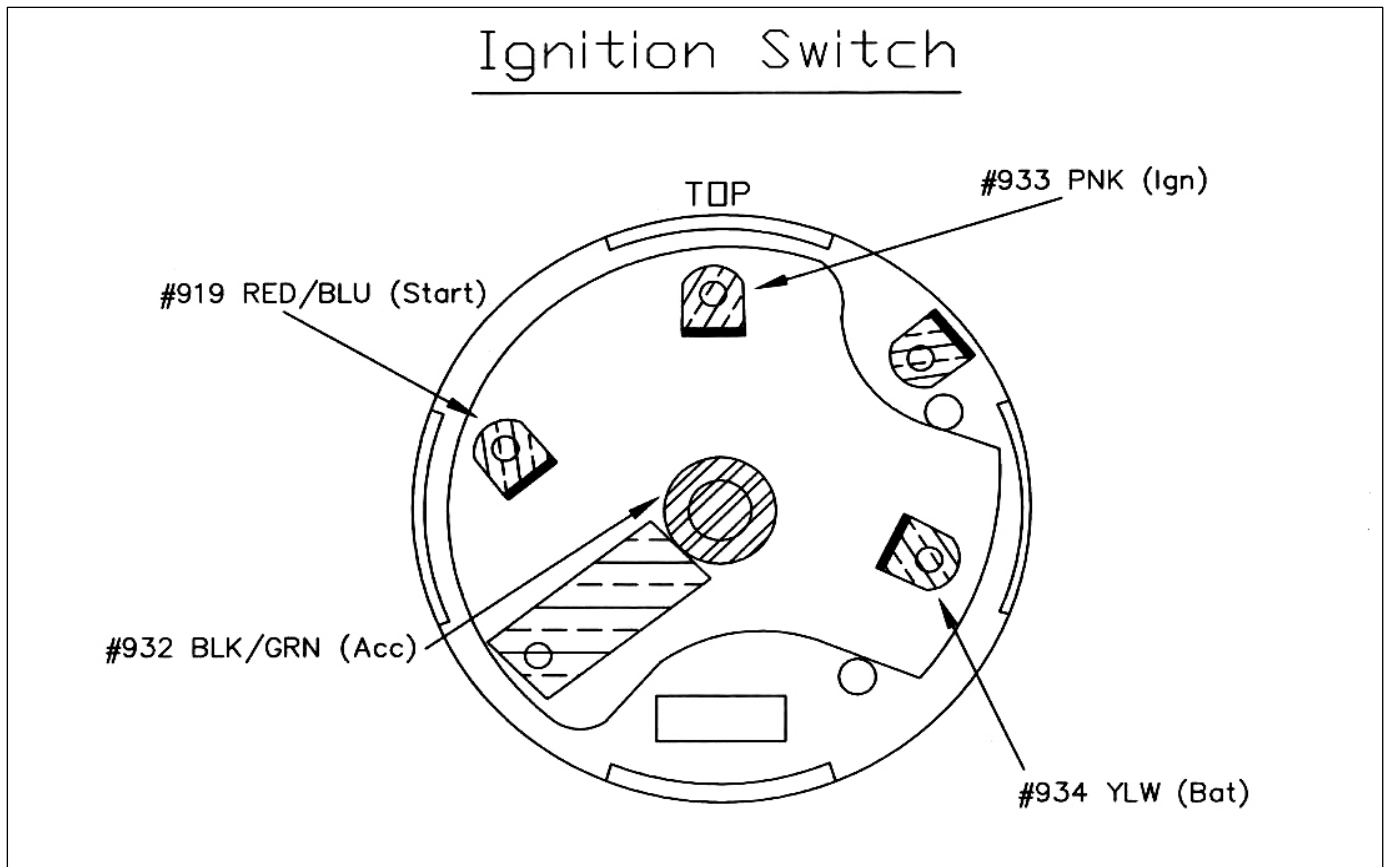

Figure 7-15 Ignition Switch Connections

7.8 Headlight Switch

7.8.1 Connect the HEADLIGHT SWITCH wires as illustrated in **Figure 7-16**. After completing the installation of the Headlight Switch wires locate the DASH GROUND #969 wire, which is directly above the steering column in the main body of the harness and connect it to the chassis ground screw behind the gauge cluster.

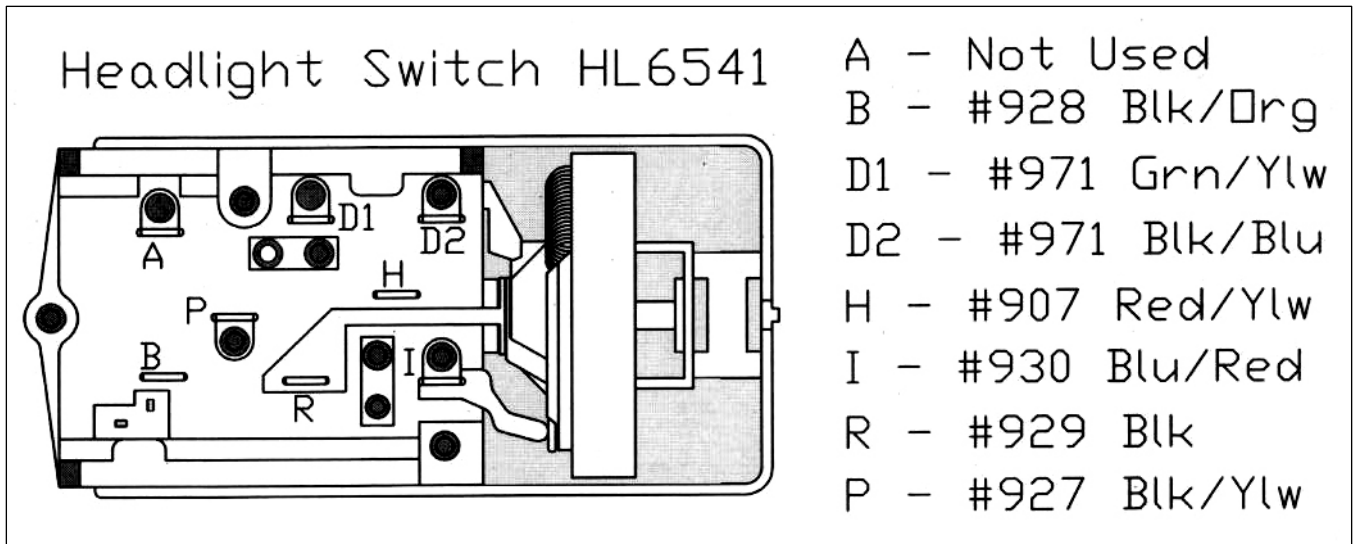

Figure 7-16 Headlight Switch Connections

7.9 Brake Lights Switch

7.9.1 Route the BRAKE SWITCH wires #917 Brake Switch B+ (Grn/Red) and #918 Brake Switch Output (Grn) over the steering column and down to the Brake Switch located on the brake pedal. Leave enough slack in the wires to allow for the brake pedal movement. These wires **are not** polarity specific, in other words it does not matter which wires goes onto each side of the switch. **See Figure 7-17.**

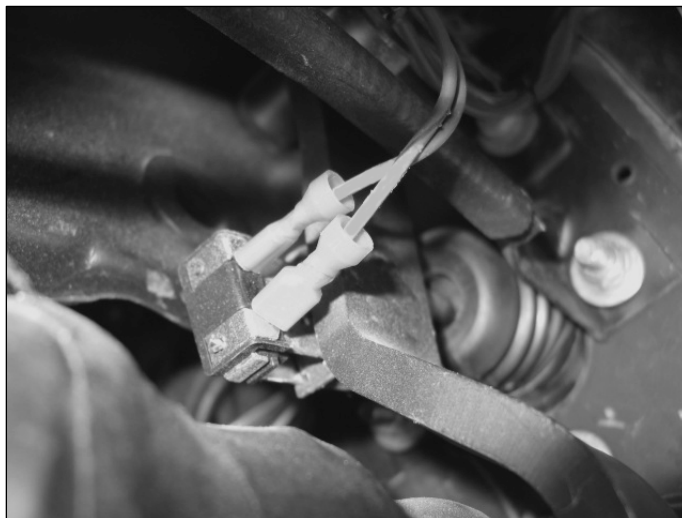

Figure 7-17 Brake Switch

7.10 Gauge Cluster Section

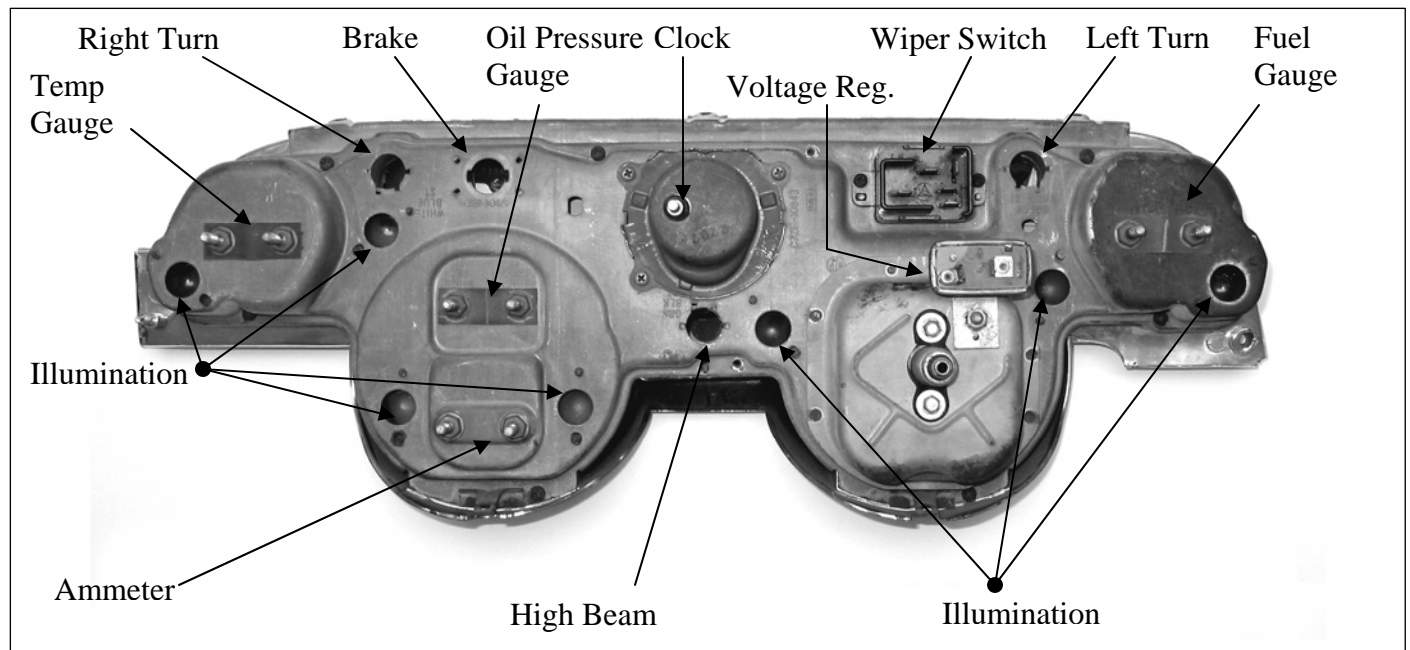

Figure 7-18 Gauge Cluster 1967 Mustang

- 7.10.1** The Gauge Cluster on the 1967 Mustang has each wire color stamped into the metal next to each connection, with exception of the illumination light sockets. The Painless Gauge Cluster harness in this kit was designed to match these designations.
- 7.10.2** With the Gauge Cluster positioned as in **Figure 7-18** and the harness completely installed, the 15 way connector on the Cluster Harness will be directly above the two terminals for the fuel gauge.
- 7.10.3** The illumination wires are (Blue/Red) and (Blk). Each of the illumination light sockets has one of each of these wires. There are a total of seven of these light sockets. Lay the harness over the cluster and route and install each of the illumination sockets. **See Figure 7-18.**

Note: If wiring a 1968 Mustang be sure to read 7.10.11 before going any farther.

- 7.10.4** The temperature gauge is on the far left. Connect the (red/wht) wire to the left post and the (blk/grn) wire to the right post.
- 7.10.5** The oil pressure gauge and amp meter are in the same gauge pod. Connect the (wht/red) wire to the left post on the oil pressure gauge and the (blk/grn) wire to the right post. On the amp meter, connect the (ylw) wire to the left post and the (red) wire to the right post.
- 7.10.6** Next install the light socket with a (wht/blu) wire and a (blk) wire into the right hand turn signal indicator hole. Now locate the light socket with a (red/ylw) wire and a (pur) wire. This socket is for the Brakes indicator lamp.

Note: On 1967 and 1968 Mustangs the amp meter is a shunt type. What this means is this type of amp meter only uses a sample of the current in the charging system as opposed to handling all the current. As wired per the original Mustang harnesses, these shunt type amp meters will only read a discharge. Even with the engine running and the charging system working properly the amp meter will be measuring the draw on the vehicles harness. The amp meters in the '67-'68 Mustangs are simply not going to indicate a charge.

NOTE: To check the Mustangs charging system, after the entire harness has been installed, connect a DC voltmeter across the battery with the engine running. A good charging system will measure between 13-14.5 volts. This voltage measurement can be affected by different sized pulleys and different engine idle rpms.

- 7.10.7 If so equipped, the single (lt blu/blk) wire is to be connected to the back of the clock. If a clock is not going to be connected, tape up and stow this wire with electrical tape.
- 7.10.8 Locate the socket with a (lt grn/blk) wire and a (blk) wire and install it into the high beam indicator hole.
- 7.10.9 Remove the Voltage Regulator mounting nut and install the single black wire with the ring terminal. Next locate the male spade terminal crimped on the end of **two** (blk/grn) wires and connect it to the left terminal on the voltage regulator. The female spade terminal with **one** (blk/grn) wire goes onto the right terminal of the voltage regulator.
- 7.10.10 Next install the light socket with a (grn/wht) wire and a (blk) wire into the left hand turn signal indicator hole. The last two wires are for the Fuel Gauge. The (ylw/wht) goes onto the left post and the (blk/grn) on the right post. This completes the Gauge Cluster Section.
- 7.10.11 The difference between a 1967 Mustang Gauge Cluster vs. a 1968 Mustang Gauge Cluster is the location of the Fuel Gauge and the Oil Pressure Gauge. These two gauges are in the opposite location on a 1968 as compared to a 1967. Because of this the two wires that will be different are the (wht/red) and the (ylw). Be sure to install the (wht/red) on the Oil Pressure Gauge left hand post and the (ylw) on the Fuel Gauge left hand post.

7.11 Heater-A/C Components

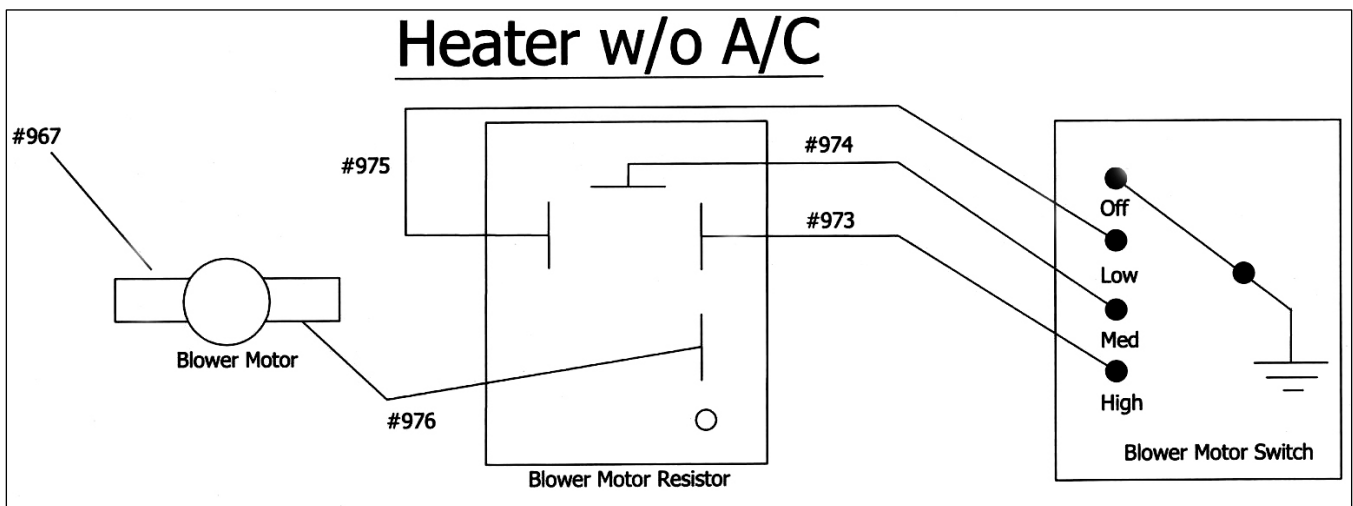

Figure 7-19 Blower Motor/Blower Motor Resistor/Blower Motor Switch

- 7.11.1 The connections for the Blower Motor, Blower Motor Resistor and Blower Motor Switch in a Mustang with a **Heater ONLY** are illustrated in **Figure 7-19**. The ground for the Blower Motor Switch is internal to the switch, meaning there are no connections to be made. The wire colors on wire numbers 973, 974, & 975 all match the wire colors coming out of the switch. The wire #976 (ylw) connects to the Orange wire on the blower motor. The wire #967 (brn) connects to the Black wire on the blower motor.

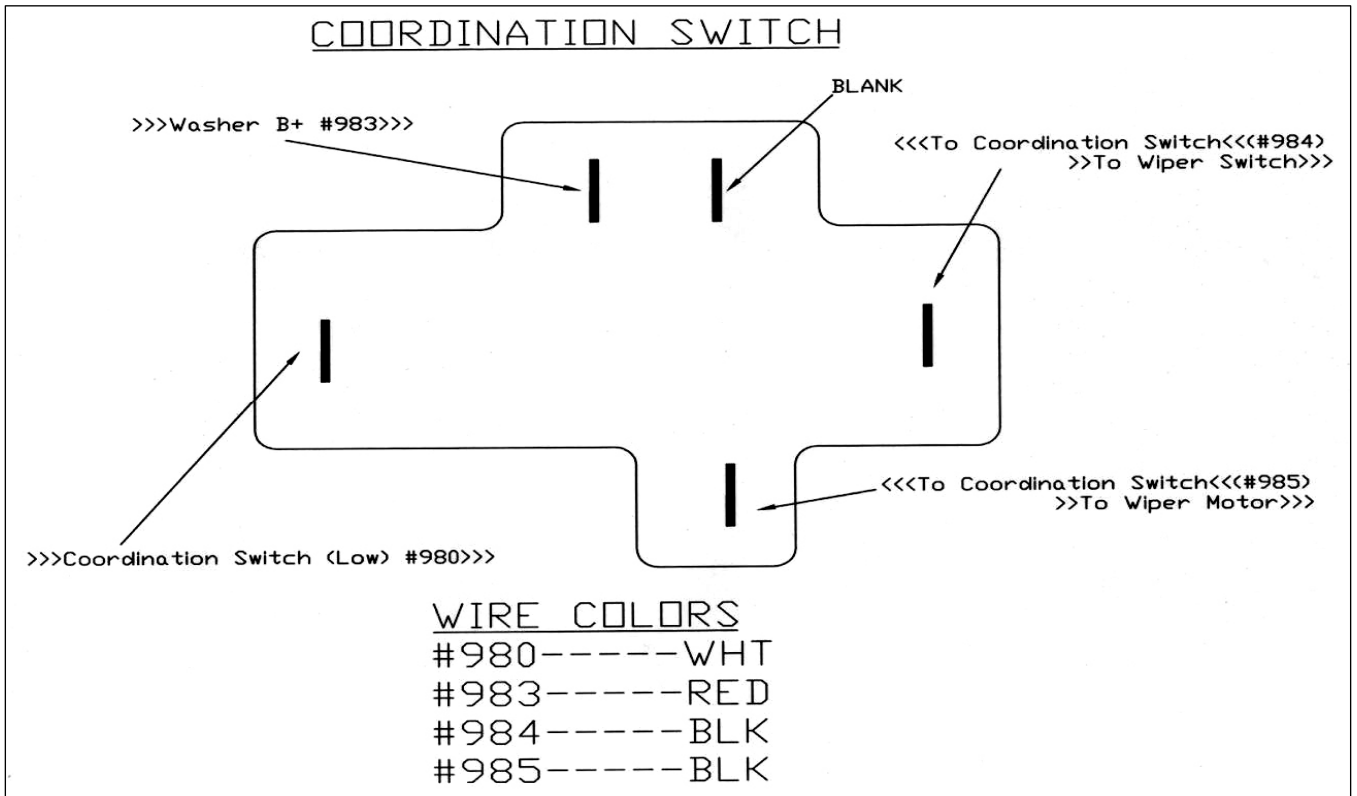

Figure 7-22 Coordination Switch

- 7.12.1** The connections for the Wiper Switch in the cluster are illustrated in **Figure 7-21**.
- 7.12.2** The connections for the Coordination Switch on the floor near the drivers kick panel are illustrated in **Figure 7-22**. The Coordination Switch wires and the Headlight Dimmer Switch wires are bundled together. After connecting the Coordination Switch wires, connect the following for the Dimmer Switch: Dimmer Switch B+ #907 to the center spade terminal, Dimmer Switch (Low Beams) #909 and Dimmer Switch (High Beams) #908 each to one of the outside spade terminals.

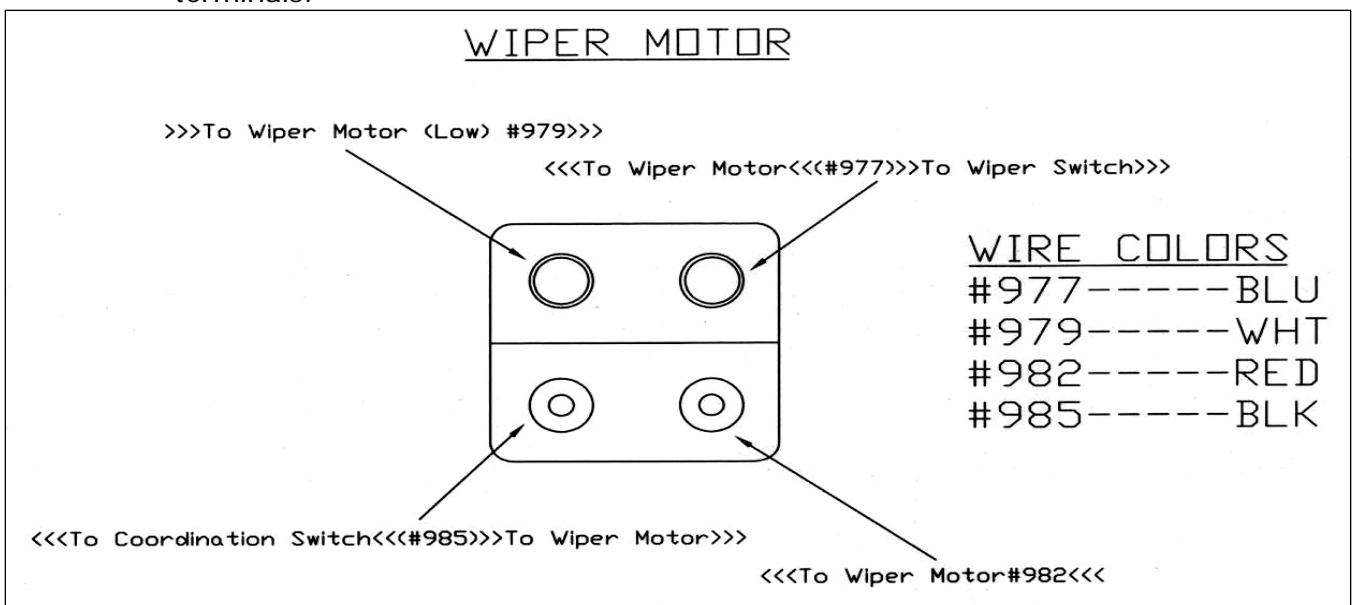

Figure 7-23 Wiper Motor Plug

7.12.3 The connections for the Wiper Motor are illustrated in **Figure 7-23**. Be sure to note the cavities for wire #979 and #977 are female and for #985 and #982 are male bullets.

7.13 Interior Lighting and Accessories

7.13.1 The interior lighting circuit is activated by three different switches. One switch is located inside the headlight switch and the other two are located in each door jamb. The door jamb wires for each switch are pre-terminated and will plug directly into the 1967 style Mustang door jamb switches. The switches on the 1968 Mustang use a different style terminal and will require splicing onto the original switch connectors. One #987 and one #988 wire connect to each of the door jamb switches. All are marked for which door jamb switch they connect to and are not polarity specific.

7.13.2 The interior lights supported by this harness include: both Left and Right Hand Courtesy Lights (#989) under the dash, Dome Light (#945), Trunk Light (#946), and if so equipped both "B" pillar lights. The "B" pillar lights are located in the interior panels behind the driver and passenger front seats. To power these, use the splice on each of the door jamb switches #988 wires.

7.13.3 The Glove Box Light Switch B+ #990 connects to the glove box light. Cigar Lighter B+ #903 connects directly to the Cigar lighter power terminal.

7.13.4 The Console Light B+ #930, Radio Light B+ #930, the Tachometer Light B+ #930, and the Gauge Cluster Illumination Lights are all controlled by the Headlight Switch dimmer circuit when the Headlights or Park lights are ON. Each wire description dictates the component to connect them to.

7.13.5 Constant Radio B+ #940 is to be connected to the Memory or Constant input on an aftermarket stereo. (Most CD players with a clock require this input) The Switched Radio B+ #941 is another wire required on most stereos.

7.13.6 If a Tachometer is to be installed use wires: Tachometer B+ #966, Tachometer Signal #923 and the Tachometer Light B+ #930 wire described in step 7.13.4.

7.13.7 The final Accessory component in this Mustang chassis harness is a 20amp accessory relay output. The relay is preinstalled in the fuse block, powered, and fused. **See Figure 7-24.**

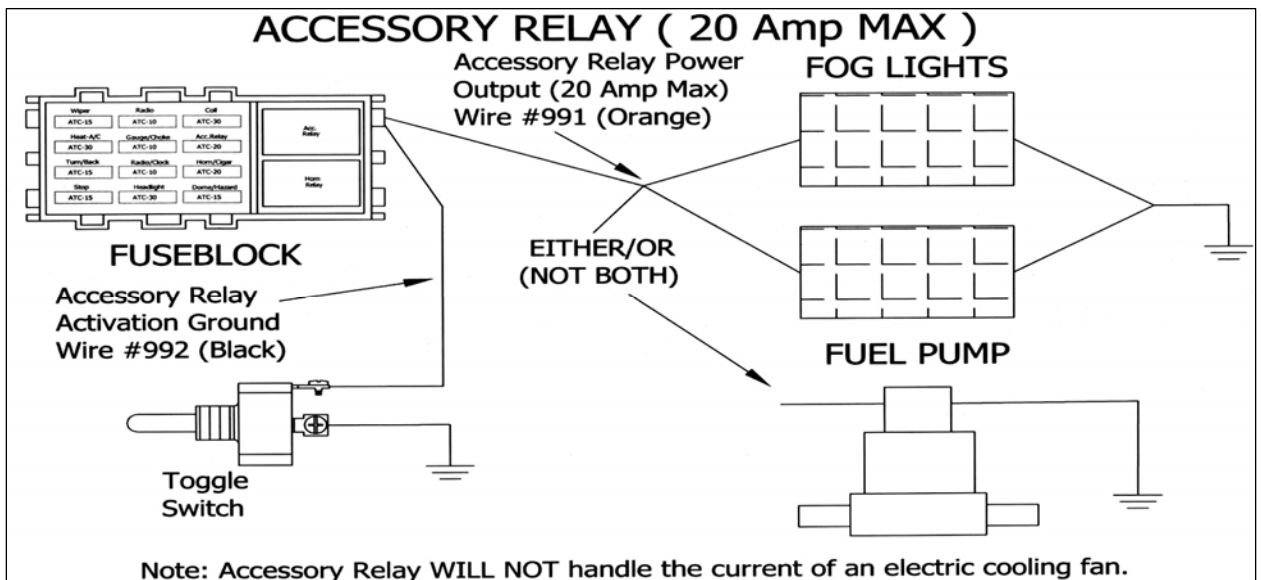

Figure 7-24 Accessory Relay Diagram

8.0 WIRE CONNECTION INDEX AND FUSE REQUIREMENTS

8.1 Wire Connection Index

In each section, connect the wire, as identified by its wire color, to the appropriate item in the Wire Ending Point column.

Table 8.2 is divided into sections that correspond to the sections of your wire harness. (ENGINE SECTION, HEADLIGHT SECTION, GAUGE CLUSTER SECTION, UNDER DASH SECTION, INTERIOR LIGHTING SECTION, AND REAR LIGHT SECTION) The index is divided vertically into six columns. COLOR, GAUGE, NUMBER, WIRE PRINT, WIRE STARTING POINT, and WIRE ENDING POINT.

The information in these columns are for reference to help identify where each wire and what it needs to be connected to. These columns tell where each wire originates, the wire number, its function and which section of the harness the wire is in.

The column labeled NO. contains a 900-series number used to identify the wires in the diagrams in Section 6.0 and 7.0 of this manual.

The wire numbers which occur TWICE in this index indicate the connection of BOTH ENDS or a splice of wires inside the harness. Most wire segments are pre-connected at the WIRE STARTING POINT such as all the wires originating from the fuse panel. The WIRE ENDING POINT is where that wire needs to be connected.

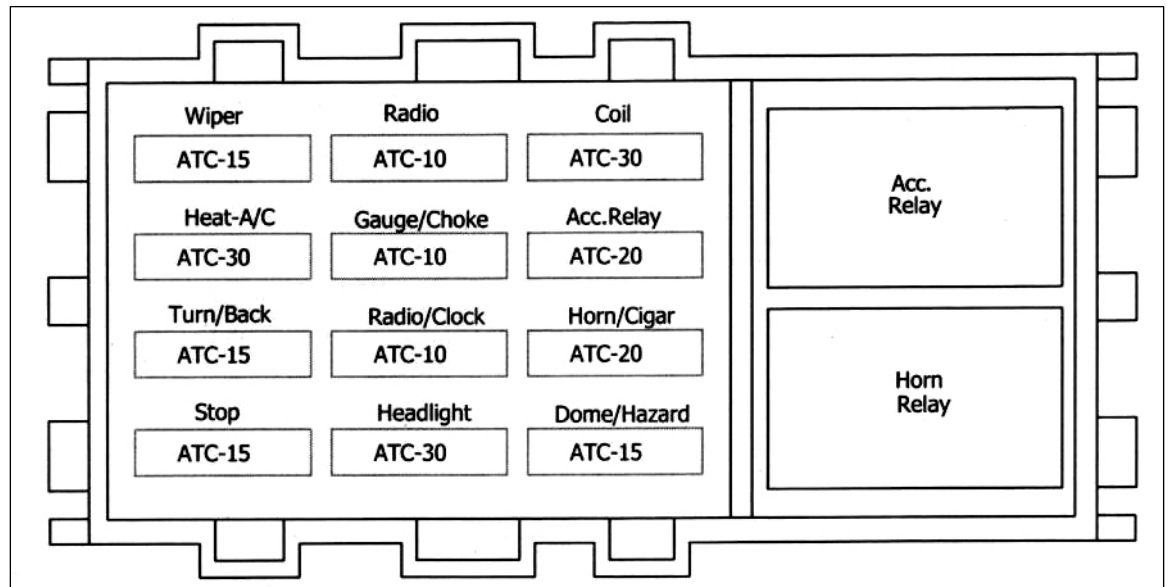

Table 8.1 Fuse Requirements

Color	Gauge	Number	Wire Print	Wire Starting Point	Wire Ending Point
ENGINE SECTION					
Red	18	954	Electric Choke B+	Fuse Block	Electric Choke
Red/Grn	14	920	Coil B+	Fuse Block	Coil "+ "
Red/Wht	18	921	Temperature Sending Unit	Temperature Gauge	Temperature Sending Unit
Wht/Red	18	922	Oil Pressure Sending Unit	Oil Pressure Gauge	Oil Pressure Sending Unit
Brn	16	970	Ignition Bypass	Starter Solenoid "I" Post	Coil "+ "
Red/Ylw	18	923	Tachometer Signal	Tachometer	Coil "- "
Blk/Red	18	958	Back-Up Light Switch B+	Fuse Block	Neutral Safety/Back-Up Lights Switch
Blk/Red	18	956	Back-Up Lights	Back-Up Light Switch	Back-Up Lights
Red/Blk	14	919	Ignition Switch "Start"	Ignition Switch	Neutral Safety/Back-Up Light Switch
Red/Blu	14	919	Starter Solenoid	Neutral Safety/Back-Up Light Switch	Starter Solenoid "S" Post
HEADLIGHT SECTION					
Brn	16	970	Ignition Bypass	Coil "+ "	Starter Solenoid "I" Post
Red/Blu	14	919	Starter Solenoid	Neutral Safety/Back-Up Light Switch	Starter Solenoid "S" Post
Blk/Ylw	10	916	Battery Source (Maxi Fuse)	Fuse Block	Starter Solenoid B+
Wht	14	914	Alternator Exciter	Voltage Regulator	Alternator "FLD" Post
Blk/Ylw	10	915	Alternator Output	Fuse Block	Alternator Output Post
Blu/Ylw	16	924	Horn B+	Horn Relay	Left and Right Horns
Grn/Wht	18	926	Left Front Turn Signal	Turn Signal Switch	Left Front Turn Signal
Wht/Blu	18	925	Right Front Turn Signal	Turn Signal Switch	Right Front Turn Signal
Blk/Ylw	18	927	Park Lights	Headlight Switch	Front Park Lights
Pur	18	968	Brake Warning	Brake Light	Proportioning Valve

Table 8.2 Wire Connection Index

Color	Gauge	Number	Wire Print	Wire Starting Point	Wire Ending Point
HEADLIGHT SECTION cont'					
Red/Blk	14	909	Low Beam	Dimmer Switch	Low Beam Headlights
Grn/Blk	14	908	High Beam	Dimmer Switch	High Beam Headlights
GAUGE CLUSTER SECTION					
Wht/Red	18		Connector Pin (1)	Oil Sending Unit	Oil Gauge
Grn/Blk	18		Connector Pin (2)	Dimmer Switch	High Beam Indicator
Blk/Grn	18			Constant Voltage Unit	6V Source for Gauges
Blk	18		Connector Pin (3)	Chassis Ground	Dash Ground
Ylw/Wht	18		Connector Pin (4)	Fuel Sending Unit	Fuel Gauge
Blk/Grn	18		Connector Pin (5)	Fuse Block	12V to Constant Voltage Unit
Blu/Red	18		Connector Pin (6)	Headlight Switch	Dash Lights B+
Ylw	18		Connector Pin (7)	Fuse Block	Amp Gauge
Red	18		Connector Pin (8)	Starter Solenoid	Amp Gauge
Wht/Blu	18		Connector Pin (9)	Turn Signal Switch	Right Turn Indicator
Red/Wht	18		Connector Pin (10)	Temperature Sending Unit	Temperature Gauge
Pur	18		Connector Pin (11)	Emergency Brake	Brakes Indicator Light
Red/Ylw	18		Connector Pin (12)	Fuse Block	Brake Light B+
Blu/Blk	18		Connector Pin (13)	Fuse Block	Clock B+
Grn/Wht	18		Connector Pin (14)	Turn Signal Switch	Left Turn Indicator
Blank			Connector Pin (15)		
UNDER DASH SECTION					
Headlight Switch					
Blk/Orn	12	928	Headlight Switch B+	Fuse Block	Headlight Switch Terminal "B"
Blu/Red	16	930	Instrument Panel Lighting	Gauges, Console, Radio, and Tach Lights	Headlight Switch Terminal "I"
Red/Ylw	14	907	Dimmer Switch B+	Dimmer Switch	Headlight Switch Terminal "H"

Table 8.2 Wire Connection Index

Color	Gauge	Number	Wire Print	Wire Starting Point	Wire Ending Point
UNDER DASH SECTION Con't					
Headlight Switch Cont'					
Blk/Ylw	16	927	Park Lights	Park Lights	Headlight Switch Terminal "P"
Blk	14	929	Tail Lights	Tail Lights	Headlight Switch Terminal "R"
Grn/Ylw	18	971	Dome B+ to Headlight Switch (D1)	Fuse Block	Headlight Switch Terminal (D1)
Blk/Blu	18	971	Dome B+ to Headlight Switch (D2)	Dome and Trunk Lights	Headlight Switch Terminal (D2)
Ignition Switch Connections					
Ylw	12	934	Ignition Switch B+	Maxi Fuse	Ignition Switch
Blk/Grn	14	932	Ignition Switch Accessory	Fuse Block	Ignition Switch
Pnk	12	933	Ignition Switched Ignition	Fuse Block	Ignition Switch
Red/Blk	14	919	Starter Solenoid	Neutral Safety/Back-Up Light Switch	Ignition Switch
Turn Signal Switch					
Grn/Orn	14	949	Left Rear Turn Signal	Left Rear Turn/Stop Light	Turn Signal Switch
Wht/Red	16	951	Emergency Flasher Switch B+	Emergency Flasher	Turn Signal Switch
Blu	14	952	Turn Signal Flasher Switch B+	Turn Signal Flasher	Turn Signal Switch
Grn	14	918	Brake Switch Output	Brake Switch	Turn Signal Switch
Grn/Wht	18	926	Left Front Turn Signal	Left Front Turn Signal	Turn Signal Switch
Wht/Blu	18	925	Right Front Turn Signal	Right Front Turn Signal	Turn Signal Switch
Orn/Blk	14	948	Right Rear Turn Signal	Right Rear Turn/Stop Light	Turn Signal Switch
Blk	18	963	To Horn Switch	Horn Relay	Turn Signal Switch
Blk	18	963	Horn Switch Ground	Chassis Ground	Turn Signal Switch
Grn/Wht	18		Left Hood Turn Signal Indicator (Optional)	Left Hood Turn Indicator	Turn Signal Switch
Wht/Blu	18		Right Hood Turn Signal Indicator (Optional)	Right Hood Turn Indicator	Turn Signal Switch

Table 8.2 Wire Connection Index

Color	Gauge	Number	Wire Print	Wire Starting Point	Wire Ending Point
UNDER DASH SECTION Con't					
Wiper Switch					
Orn/Wht	16	905	Wiper Motor B+	Fuse Block	Wiper Motor
Blu	16	977	To Wiper Switch/To Wiper Motor	Wiper Motor	Wiper Switch
Wht	16	978	To Wiper Switch (Low)	Coordination Switch/Wiper Motor	Wiper Switch
Red	16	981	Wiper Park/Washer	Coordination Switch/Wiper Motor	Wiper Switch
Blk	16	984	To Coordination Switch/To Wiper Switch	Coordination Switch	Wiper Switch
Wiper Coordination Switch					
Wht	16	980	Coordination Switch (Low)	Wiper Motor/Wiper Switch	Coordination Switch
Red	16	983	Washer	Wiper Motor/Wiper Switch	Coordination Switch
Blk	16	984	To Coordination Switch/To Wiper Switch	Wiper Switch	Coordination Switch
Blk	16	985	To Wiper Motor/To Coordination Switch	Wiper Motor	Coordination Switch
Wiper Motor					
Blu	16	977	To Wiper Switch/To Wiper Motor	Wiper Switch	Wiper Motor
Wht	16	979	To Wiper Motor (Low)	Wiper Switch	Wiper Motor
Red	16	982	Wiper Motor	Coordination Switch/Wiper Switch	Wiper Motor
Blk	16	985	To Wiper Motor/To Coordination Switch	Coordination Switch	Wiper Motor
Brake Switch					
Grn/Red	14	917	Brake Switch B+	Fuse Block	Brake Switch
Grn	14	918	Brake Switch Output	Turn Signal Switch	Brake Switch
Dimmer Switch					
Grn/Blk	14	908	Dimmer Switch (High Beam)	High Beams	Dimmer Switch
Red/Blk	14	909	Dimmer Switch (Low Beam)	Low Beams	Dimmer Switch
Red/Ylw	14	907	Dimmer Switch B+	Headlight Switch	Dimmer Switch "Center Spade"

Table 8.2 Wire Connection Index

Color	Gauge	Number	Wire Print	Wire Starting Point	Wire Ending Point
UNDER DASH SECTION Con't					
Be sure to follow Figure 7-19 for Heater only and Figure 7-20 for Heater and A/C.					
Blower Motor					
Brn	14	967	Blower Motor B+	Fuse Block	Blower Motor
Ylw	14	976	To Blower Motor/To Blower Motor Resistor	Blower Motor Resistor	Blower Motor
Heat-A/C Blower Motor Resistor					
Blk/Ylw	14	973	Blower Motor (High)	Heat-A/C Switch	Blower Motor Resistor
Blu	14	974	Blower Motor (Med)	Heat-A/C Switch	Blower Motor Resistor
Red	14	975	Blower Motor (Low)	Heat-A/C Switch	Blower Motor Resistor
Ylw	14	976	To Blower Motor Resistor/To Blower Motor	Blower Motor	Blower Motor Resistor
Blower Motor Switch					
Blk/Ylw	14	973	Blower Motor (High)	Blower Resistor Block	Blower Motor Switch
Blu	14	974	Blower Motor (Med)	Blower Resistor Block	Blower Motor Switch
Red	14	975	Blower Motor (Low)	Blower Resistor Block	Blower Motor Switch
Under-Dash Section Accessories					
Blk/Wht	14	903	Cigar Lighter B+	Fuse Block	Cigar Lighter
Blk/Red	18	930	Tachometer Light B+	Headlight Switch	Tachometer Light
Red	18	966	Tachometer B+	Fuse Block	Tachometer Power
Red/Ylw	18	923	Tachometer Signal	Engine Section	Tachometer Signal
Orn	16	991	Accessory Relay Power Output (20 Amp Max)	Accessory Relay	20 Amp or less Accessory
Blk	18	992	Accessory Relay Activation Ground	Accessory Relay	Ground Activation Switch
Blu/Red	18	930	Radio Light B+	Headlight Switch	Light in Radio
Red	18	940	Constant Radio B+	Fuse Block	Radio
Ylw/Blk	18	941	Switched Radio B+	Fuse Block	Radio
Pur	18	968	Brake Warning	Brake Light	Emergency Brake Switch

Table 8.2 Wire Connection Index

Color	Gauge	Number	Wire Print	Wire Starting Point	Wire Ending Point
INTERIOR LIGHTING SECTION					
Grn/Ylw	18	988	To Right Door Jamb Switch B+	Fuse Block	Right Door Jamb Switch
Blk/Blu	18	988	To Right Door Jamb Switch	Interior Lighting Circuit	Right Door Jamb Switch
Blk/Blu	18	989	Right Courtesy Light	Right Door Jamb Switch	Right Courtesy Light
Grn/Ylw	18	987	To Left Door Jamb Switch B+	Fuse Block	Left Door Jamb Switch
Blk/Blu	18	987	To Left Door Jamb Switch	Interior Lighting Circuit	Left Door Jamb Switch
Blk/Blu	18	989	Left Courtesy Light	Left Door Jamb Switch	Left Courtesy Light
Grn/Ylw	18	990	To Glove Box B+	Fuse Block	Glove Box Light Switch
Blk/Red	18	930	Center Console Light B+	Headlight Switch	Center Console Light
REAR LIGHT SECTION					
Blk/Blu	18	945	To Dome Light	Headlight Switch/Jamb Switches	Dome Light
Blk/Red	18	956	Back-Up Lights	Back-Up Light Switch	Back-Up Lights
Grn/Orn	14	949	Left Rear Turn Signal	Turn Signal Switch	Left Rear Turn/Stop Signal
Orn/Blu	14	948	Right Rear Turn Signal	Turn Signal Switch	Right Rear Turn/Stop Signal
Ylw/Wht	18	939	Fuel Sending Unit	Fuel Gauge	Fuel Sending Unit
Blk	16	929	Tail Lights	Headlight Switch	Tail Lights
Blk	18	962	License Plate Light B+	Headlight Switch	License Plate Light
Grn/Ylw	18	946	Trunk Light B+	Headlight Switch	Trunk Light

Table 8.2 Wire Connection Index

Painless Performance Limited Warranty and Return Policy

Chassis harnesses and fuel injection harnesses are covered under a lifetime warranty.

All other products manufactured and/or sold by Painless Performance are warranted to the original purchaser to be free from defects in material and workmanship under normal use. Painless Performance will repair or replace defective products without charge during the first 12 months from the purchase date. No products will be considered for warranty without a copy of the purchase receipt showing the sellers name, address and date of purchase. You must return the product to the dealer you purchased it from to initiate warranty procedures.