



Wire Harness Installation Instructions

For Installing P/N:

10118

14 Circuit w/Switches

1967-1977 Ford F-Series Trucks

Or

10117

14 Circuit w/o Switches

1967-1977 Ford F-Series Trucks

Manual #90540



Perfect Performance Products, LLC

Painless Performance Products Division

2501 Ludelle Street

Fort Worth, TX 76105-1036

800-423-9696 phone – 817-244-4024 fax

Web Site: www.painlessperformance.com

E-Mail: painless@painlessperformance.com

If you have any questions concerning the installation of this harness or having trouble in general, feel free to call Painless Performance Products' tech line at 1-800-423-9696. Calls are answered from 8am to 5pm central time, Monday thru Friday, except holidays.

We have attempted to provide you with as accurate instructions as possible, and are always concerned about corrections or improvements that can be made. If you have found any errors or omissions, or if you simply have comments or suggestions concerning these instructions, please write us at the address on the cover and let us know about them. Or, better yet, send us a fax at (817) 244-4024 or e-mail us at painless@painlessperformance.com. We sincerely appreciate your business.

Perfect Performance Products, LLC shall in no event be liable in contract or tort (including negligence) for special, indirect, incidental, or consequential damages, such as but not limited to, loss of property damage, or any other damages, costs or expenses which might be claimed as the result of the use or failure of the goods sold hereby, except only the cost of repair or replacement.

P/N 90540 Painless Wiring Manual

March 16, 2006

Copyright © 2006 by Perfect Performance Products, LLC

TABLE OF CONTENTS

1.0	Introduction	
2.0	About These Instructions.....	1
3.0	Contents in The Painless Wire Harness Kit.....	2
4.0	Tools Needed.....	2
5.0	Pre-Installation and Harness Routing Guidelines.....	3
6.0	Harness Installation Instructions.....	4
6.1	General Installation	
6.2	Harness Attachment	
6.3	Grounding The Automobile	
6.4	Terminal Installation and Making Connections	
6.5	Testing The System	
7.0	Specific Circuit Connections.....	12
7.1	Alternator/Regulator/Solenoid	
7.2	High Amperage Alternator Kit	
7.3	Engine Section	
7.4	Headlights/Front Turn Signals/Park Lights	
7.5	Rear Light Section	
7.6	Turn Signal Connections	
7.7	Ignition Switch Connections	
7.8	Headlight Switch	
7.9	Brake Lights Switch	
7.10	Wiper Switch	
7.11	Dimmer Switch	
7.12	Cargo Light Switch	
7.13	Dome Light	
7.14	Air Conditioning/Heater Configurations	
7.15	Hazard Switch	
7.16	Gauge Cluster – 1967 - 1969 Trucks	
7.17	Gauge Cluster – 1970 - 1974 Trucks	
7.18	Gauge Cluster – 1975 - 1977 Trucks	
7.19	Ignition Switch Pinouts	
7.20	Accessories	
8.0	Wire Connection Index and Fuse Requirements.....	40

LIST OF TABLES

Table 8.1	Fuse Requirements.....	40
Table 8.2	Wire Connection Index (1 of 5).....	41
Table 8.2	Wire Connection Index (2 of 5).....	42
Table 8.2	Wire Connection Index (3 of 5).....	43
Table 8.2	Wire Connection Index (4 of 5).....	44
Table 8.2	Wire Connection Index (5 of 5).....	45

Painless Performance Products recommends, you the consumer, read this installation manual from front to back before installing this harness. Due to the variables in modifications done to these classic Ford Trucks, reading this manual will give you considerable insight on the proper installation of this harness in an original or modified application.

1.0 INTRODUCTION

Congratulations on purchasing what we at Painless Performance Products believe to be the most up-to-date and easy-to-install automotive wiring harness on the market today. This Painless wire harness is designed to be used in 1967 - 1977 Ford F-Series trucks. This harness is designed for an easy installation, even for persons with no electrical experience.

The proper fuses are pre-installed into the fuse block. All wires to be connected are color-coded and have their function printed on them to help identify the different circuits during installation. All wire is 600 volt, 257°F, TXL. Standard automotive wire is GPT, 300 volt, 176°F, with PVC insulation. For fuse specifications and wire color designations, see **Section 8.1 and Table 8.1**.

This complete Classic Ford Truck wiring system has six major sections:

ENGINE SECTION: Water temperature, oil pressure, tachometer, coil, choke, and a/c compressor clutch.

DRIVERS SIDE SECTION: High beam, low beam, park lights, left turn, horn, wiper washer motor, and proportioning valve

PASSENGER SIDE SECTION: High beam, low beam, park lights, right turn, horn, voltage regulator, starter solenoid, battery feed and alternator.

GAUGE CLUSTER SECTION: '67-'69 gauge cluster harness, '70-'74 gauge cluster pigtail adapter, '75-'77 gauge cluster pigtail adapter,.

UNDER-DASH SECTION: Heater-a/c switch, headlight switch, turn signal switch, glove box hazard switch, radio, tachometer, ignition switch, cigar lighter, dimmer switch, brake switch, heater-a/c resistor, heater blower motor, wiper switch, wiper motor, cargo light switch, cargo light, right and left door jam switches and courtesy lights.

TAIL SECTION: Includes taillights, stoplights, left and right turn signals, backup lights, license plate light, and fuel sending unit.

2.0 ABOUT THESE INSTRUCTIONS

The contents of these instructions are divided into major **Sections**:

- 1.0 Introduction
- 2.0 About These Instructions
- 3.0 Contents of Painless Wire Harness Kit
- 4.0 Tools Needed
- 5.0 Pre-Installation and Harness Routing Guidelines
- 6.0 Harness Installation Instructions
- 7.0 Specific Circuit Connections
- 8.0 Wire Connection Index and Fuse Requirements

Sections are divided into subsections and **Paragraphs**. Throughout these instructions, the **Figure** numbers refer to illustrations and the **Table** numbers refer to information in table form. These are located in Sections or Paragraphs corresponding to the number. Always pay special and careful attention to any *Notes*, especially those in the Tables, and any text marked **Caution**.

3.0 CONTENTS OF THE PAINLESS WIRE HARNESS KIT

Refer to the list below to take inventory of all the parts in this kit. If anything is found to be missing, contact the dealer the kit was purchased from or Painless Performance at (800)423-9696. The 1967–1977 Ford F-Series Truck Wire Harness Kit contains the following items:

- The Main Wire Harness, with Fuse Block pre-wired fuses and relays installed.
- Pig Tails: Headlight Connector Harnesses, A/C Harness, Cluster Harness, Front Lights Ground Harnesses, Tail Ground Harness and 1968 Turn Signal Harness.
- Bag Kit: 1 pkg. of small and 1 pkg. of large Nylon Tie Wraps, Ballast Resistor, Maxi Fuse, Firewall Grommets, 1968 Ignition Switch and a Fuse Identification Label.
- Parts Box containing Terminals, Splices, Spare Fuses etc.
-



Figure 3-1 Painless Wire Harness Kit

4.0 TOOLS NEEDED

In addition to basic hand tools the following will also be needed:

- Crimping Tool *Note: Use a quality tool to avoid over-crimping.*
- Wire Stripper
- Test Light or Volt Meter
- Small (10 amp or less) Battery Charger

5.0 PRE-INSTALLATION AND HARNESS ROUTING GUIDELINES

Installation of this wire harness consists mainly of two parts:

- The physical routing and securing of the wire harness.
- The connection of the individual circuits to their components.

These two major tasks are not separate steps, but are integrated together. In other words, each section of wires are to be routed and then connected to their components. Route the next section of wires and make those sections connections. The layout of this 1967-1977 Ford F-Series harness will dictate how to physically route the harness in your truck. The breakouts and connections are very close to the original Ford harnesses and will fit just as well, if not better. It's a good idea to document how the original harness was routed as this new one follows most of the same routing. The fitment greatly depends on what extent the installer takes to secure and conceal the harness. Painless offers some general guidelines and routing practices starting in **Section 5.2**, GENERAL installation instructions in **Section 6.0**, and precise instructions concerning the electrical connections you will make in **Section 7.0**. To help you begin thinking through the installation of your wire harness please read the following sections:

- 5.1** Familiarize yourself with the harness by removing the harness from the box, laying it out on a table or on the floor and locating each of the harness sections in the following list. Whenever a particular harness section is referred to in these instructions it is shown in "all caps": ENGINE SECTION.



ENGINE SECTION
DRIVERS SIDE SECTION
PASSENGER SIDE SECTION
GAUGE CLUSTER SECTION
UNDER-DASH SECTION
TAIL SECTION

- 5.2** Be sure to route the harness around and through open areas inside the car. Inside edges provide protection from hazards and also provide places for tie wraps, clips, and other support.
- 5.3** Route the harness away from any sharp edges, exhaust pipes, hood, trunk and door hinges.
- 5.4** Plan where harness supports will be located. Allow enough slack in places where movement could occur (body to frame, frame to engine, etc.)
- 5.5** At wire ends, don't depend on the terminals to support the harness. The weight of the harness may cause the terminals or the copper wire strands to break.
- 5.6** Bundle the wires into groups. Use nylon ties, poly split loom, tape or PowerBraid (Painless P/N's 70901(1/4"), 70902(1/2"), 70903(3/4") and 70904(1 1/2").

6.0 HARNESS INSTALLATION INSTRUCTIONS

6.1 General Installation

CAUTION: *DISCONNECT THE POWER FROM YOUR VEHICLE BY REMOVING THE NEGATIVE (BLACK) BATTERY CABLE FROM THE BATTERY.*

Note: Be sure to retain Overdrive Transmission wiring and Cruise Control wiring when removing the old harness. Circuits for these accessories are not included in this harness.

- 6.1.1** Mount the base in the stock fuse block location with two of the self tapping screws from the parts kit. **See Figure 6-2 for '67-'72 models or Figure 6-3 for '73-'77 models.**



Figure 6-2 Fuse Block Base Position '67-'72

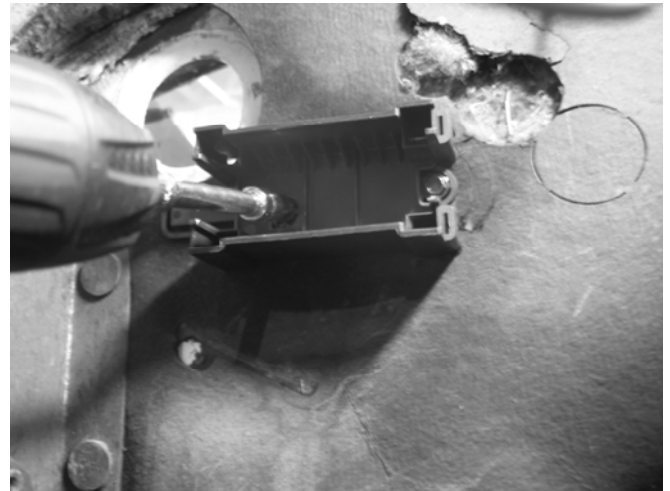

Figure 6-3 Fuse Block Base Position '73-'77

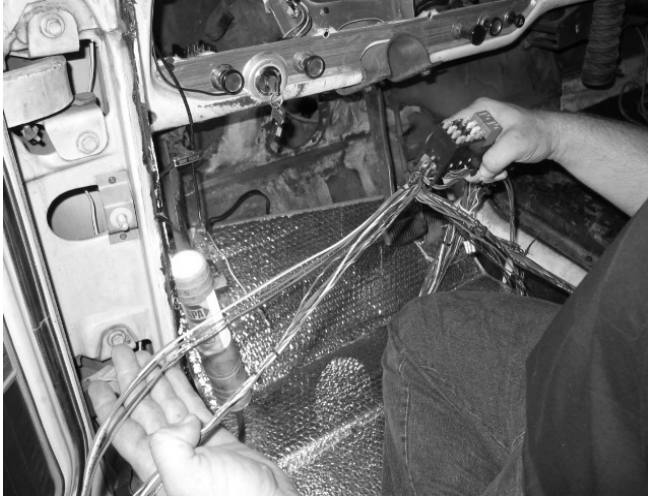

Figure 6-4 Routing Fuse Block to Base



Figure 6-5 Snapping Fuse Block into Base

6.1.2 Route the fuse block and attached harness under the dash and through the opening by the brake pedal. Now snap it into the fuse block base. **See Figures 6-4 & 6-5 for '67-'72 model trucks AND Figure 6-6 for '73-'77 model trucks.**

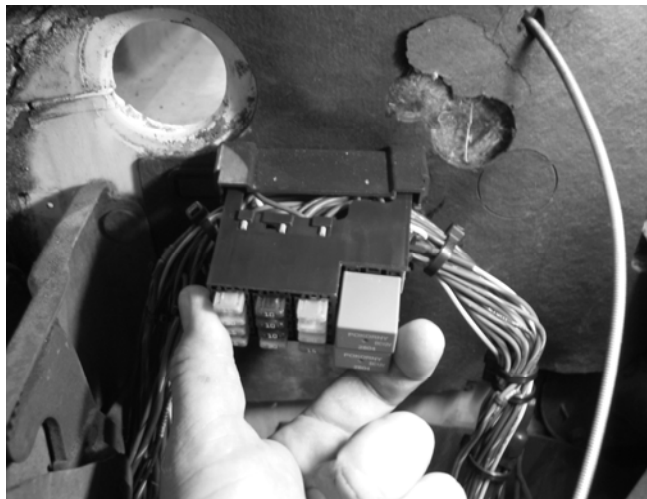

Figure 6-6 Snapping Fuse Block into Base

6.1.3 Route the harness around the steering column/dash support using the original harness support clips on the body. Carefully remove any extra slack in the harness. **See Figures 6-7 & 6-8.**



Figure 6-7 Firewall Clip



Figure 6-8 Steering Column Harness Clips

6.1.4 On **'67-'72 models only**, locate the two 1 7/8" grommets included in the parts kit. Install one grommet into the hole directly above and to the left of the fuse block. Install the second grommet into the hole on the opposite side of the truck in the firewall behind the passenger side hood hinge. Now locate and gently pull through the **DRIVERS SIDE SECTION** and the **TAIL SECTION** wires through the Drivers side grommet in the firewall. Next pull the **PASSENGER SIDE SECTION** through the harness clip in the middle of the dash and then through the firewall grommet on the passenger side. **See Figure 6-9, 6-10 & 6-11 for '67-'72 models only.**

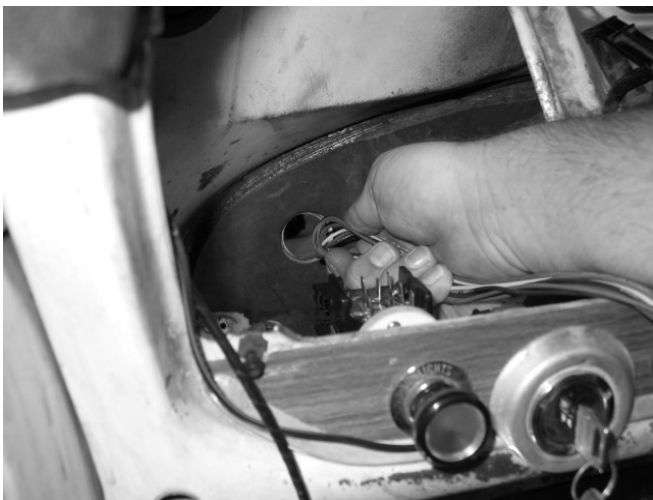

Figure 6-9 DRIVER & TAIL SECTIONS



Figure 6-10 Original Harness Clips



Figure 6-11 PASSENGER SIDE SECTION

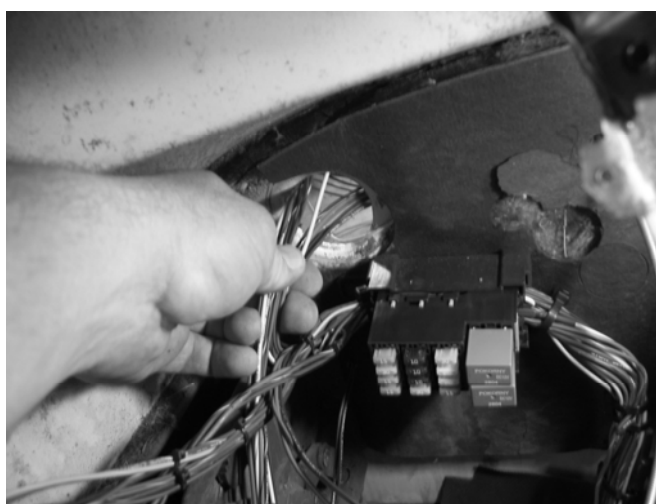

Figure 6-12 DRIVER & TAIL SECTIONS



Figure 6-13 '73-'77 Original Grommets

6.1.5 On **'73-'77 models only**, it is necessary to reuse the original firewall grommets. Feed the DRIVERS SIDE SECTION and the TAIL SECTION wires through the Drivers side grommet in the firewall. Carefully feed the ENGINE SECTION and the PASSENGER SIDE SECTION through the firewall grommet located behind the engine's passenger side valve cover. **See Figures 6-12, 6-13 & 6-14.**



Figure 6-14 PASSENGER AND ENGINE SECTIONS

6.1.6 On **'67-'72 models only**, locate the 1 1/4" grommet included in the parts kit. This grommet is for the **ENGINE SECTION** of the harness, which goes through the center of the firewall, behind the engine's driver side valve cover. Carefully remove the old grommet and replace it with the new one provided. Then feed the **ENGINE SECTION** through the firewall. **See Figures 6-15 & 6-16.**

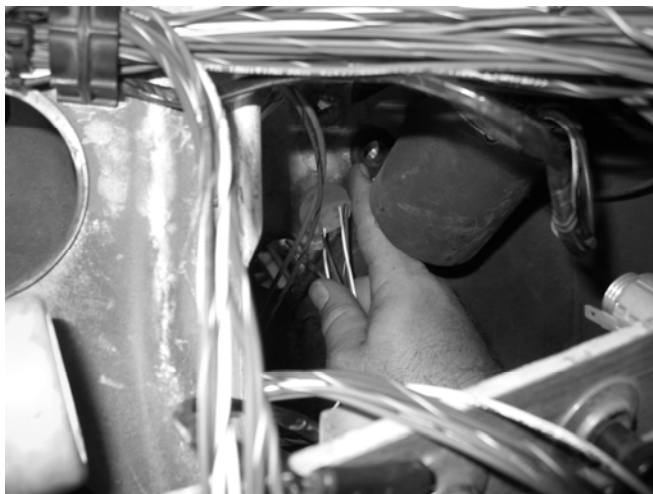

Figure 6-15 '67-'72 Models only



Figure 6-16 '67-'72 Models only

6.1.7 Now locate the **TAIL SECTION** of the harness. This section of the harness will be routed under the brake master cylinder; through the harness clips along side the driver's front fender well and down along side the frame to the rear of the truck. At the rear it will need to be separated into left and right hand turn, tail, brake, backup and license plate lights. **See Figures 6-17 thru 6-20.**

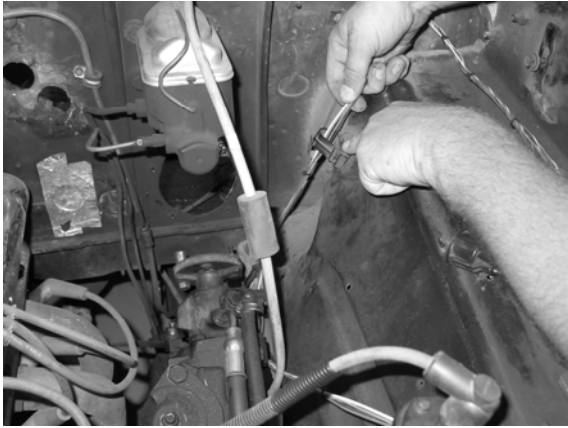

Figure 6-17 '67-'72 Models



Figure 6-18 '73-'77 Models

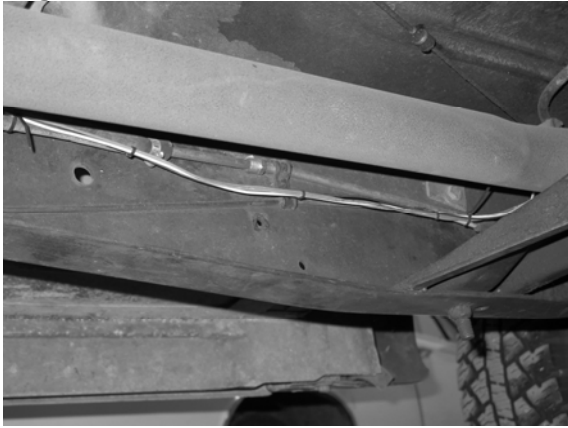

Figure 6-19 '67-'72 Models



Figure 6-20 '73-'77 Models

6.2 Harness Attachment

Harness routing and shaping is and should be a time-consuming task. Taking your time will enhance the quality of the installation.

- 6.2.1 Mold the harness to contour to under the dash, along the inner fenders, along the frame and any other areas where harness sections are routed. Remember to route the harness away from sharp edges, exhaust pipes, hood, trunk, and door hinges.
- 6.2.2 Attach harness groups to the truck with clips or zip ties starting at the fuse block and working towards the outer harness circuits. All UNDER-DASH SECTION wires should be routed out of the way of any vent levers, air conditioning controls, radio, etc.
Note: Do not tighten zip ties until each individual connection has been made on the particular circuit to be wire tied.
- 6.2.3 When using wire loom on the visible areas of the harness, it is recommended to install a zip tie every 12".

6.3 Grounding the Automobile

This Ford F-Series Truck Harness Kit includes the following ground wires: two front lights ground harnesses, two tail ground harnesses, one built-in ground wire for the horn and gauge cluster harness and a ground wire for the accessory relay. Any additional circuits or accessories requiring a ground will need to be added.

- 6.3.1 Check to see the battery ground cable is free from corrosion and is firmly bolted to the engine block.
- 6.3.2 Connect a Ground Strap from the engine block to the frame. These can be purchased at most local automotive parts suppliers. **DO NOT RELY UPON THE MOTOR MOUNTS TO MAKE THIS CONNECTION.**
- 6.3.3 Connect a Ground Strap from the engine block to the firewall on the cab of the truck.

6.4 Terminal Installation and Making Connections

*Note: In the following steps, the individual circuit connections will be made. Before starting, carefully read through **Sections 7.0** and refer to **Section 8.0** as needed. Be sure to **DOUBLE-CHECK** all routing and length calculations before cutting wires to length and making connections. The majority of the pre-terminated wires are in the **GAUGE CLUSTER** and **UNDER-DASH SECTION'S**.*

- 6.4.1 Have all needed tools and connectors handy.
- 6.4.2 Select the correct size terminal for the wire application.
- 6.4.3 Determine the correct wire length and cut the wire. Remember to allow enough slack in the harness at places where movement could occur; such as firewall to engine, frame to engine, etc.
- 6.4.4 Strip the insulation from the wire.
Note: All terminals in this kit require a ¼" strip length.
- 6.4.5 Insert the stripped portion of the wire into the crimp side of the terminal. Do not allow the individual wire strands to fray during insertion. Sometimes it may help to twist the stripped portion of the wire to avoid fraying.
- 6.4.6 Crimp the terminal onto the wire using the proper jaw location on the crimpers.
*Note: In step 6.4.6 be sure to use the proper jaw location on your crimpers. Most crimping tools have it color coded for which cavity to use. 18-22ga – Red, 16-14ga – Blue, and 12-10ga – Yellow. **CAUTION: DO NOT OVER-CRIMP!***
- 6.4.7 Many connections will be made throughout the installation process. Make sure each wire is **FIRST** properly routed and **THEN** attach. **DO NOT ATTACH FIRST AND ROUTE AFTERWARD.**
- 6.4.8 Once all the wires are terminated and securely attached tighten the zip ties to secure the harness permanently.

6.5 Testing The System

6.5.1 Use a small (10 amp or less) battery charger with an internal circuit breaker for circuit protection to power up the vehicle for the first time to test the circuits. If there is a problem anywhere, the battery charger's internal circuit breaker will provide circuit protection.

CAUTION: IF YOU HAVE NOT YET DISCONNECTED THE BATTERY FROM THE AUTOMOBILE, DO SO NOW! DO NOT CONNECT THE BATTERY CHARGER WITH THE BATTERY CONNECTED.

6.5.2 Connect the battery charger's NEGATIVE cable to the automobile chassis or engine block and its POSITIVE cable to the automobile's positive battery terminal lug.

6.5.3 INDIVIDUALLY turn on each light, ignition, wiper circuit, etc. and check for proper operation.

Note: The turn signals will not flash properly if you do not have both the front and rear bulbs installed. On 1967-1972 models the metal taillight housing MUST be installed, thus providing a ground for the turn, stop and taillights.

6.5.4 After all circuits have been checked, disconnect the battery charger and attach the vehicles battery cables securely to the battery. REPEAT STEP 6.5.3.

7.0 SPECIFIC CIRCUIT CONNECTIONS

7.1 PASSENGER SIDE SECTION - Alternator/Regulator/Solenoid

- 7.1.1 Connect PASSENGER SIDE SECTION wire #915 (Blk) to the Alternator Output post marked "Bat". **See Figure 7-2. If the truck being rewired has an ammeter, it will be necessary to connect the #972 Red and #972 Yellow wires as illustrated in Figure 7-7 on page 14.**
- 7.1.2 Connect PASSENGER SIDE SECTION wire #996 (Org) to the Alternator post marked "FLD" for Field. Next connect wire #997 (Wht/Blk) to the Alternator post marked "STA" for Stator. **See Figure 7-2**

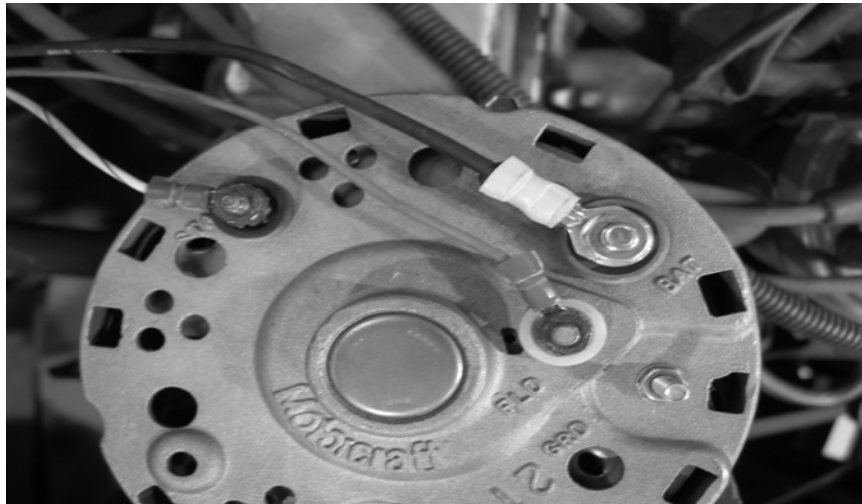

Figure 7-2 Alternator Connections '67-'77 Models

- 7.1.3 Locate the Voltage Regulator Connector in the PASSENGER SIDE SECTION and plug it into the Voltage Regulator, which is on the passenger's side engine compartment on the core support. **Note: It is critical to have the Voltage Regulator's housing grounded for proper operation.** See Figure 7-3.

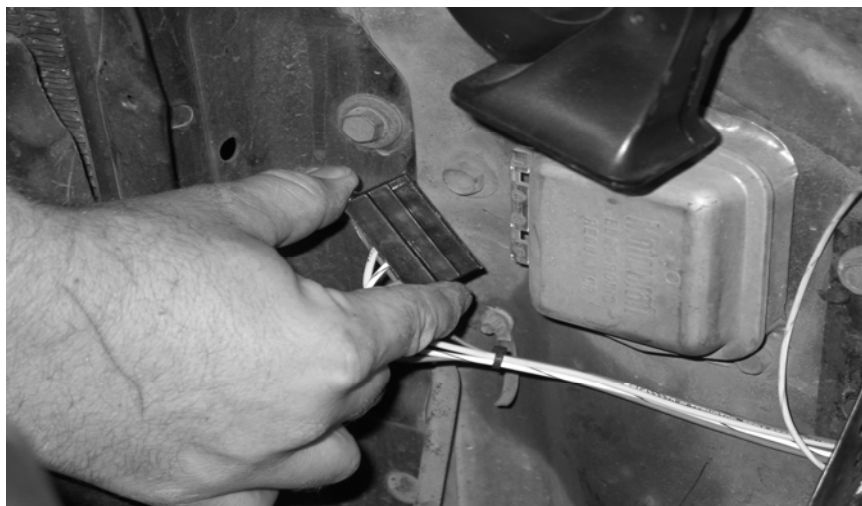

Figure 7-3 Voltage Regulator Connection '67-'77 Models

- 7.1.4** Locate the yellow/green Horn wire #924 in the PASSENGER SIDE SECTION, find a female spade terminal from the parts kit and cut and terminate the wire to the desired length. Connect to the passenger side horn. **See Figure 7-4. Note:** Some Ford Trucks have two horns (one on each side of the radiator). If so, locate the yellow/green Horn wire #924 in the DRIVERS SIDE SECTION and connect it to the driver's side horn with a female spade terminal from the parts kit. If only one of the horn wires are to be used, the unused wire **MUST** be taped up or a butt connector installed to prevent a short circuit.



Figure 7-4 Horn Connections (All Models)

- 7.1.5** Locate the Maxi Fuse Base in the parts kit and attach it to the passenger side inner fender with the provided self tapping screw. **See Figure 7-5 for '67-'72 Models and Figure 7-6 for '73-'77 Models.**



Figure 7-5 Installing the Maxi Fuse Holder '67-'72 Models

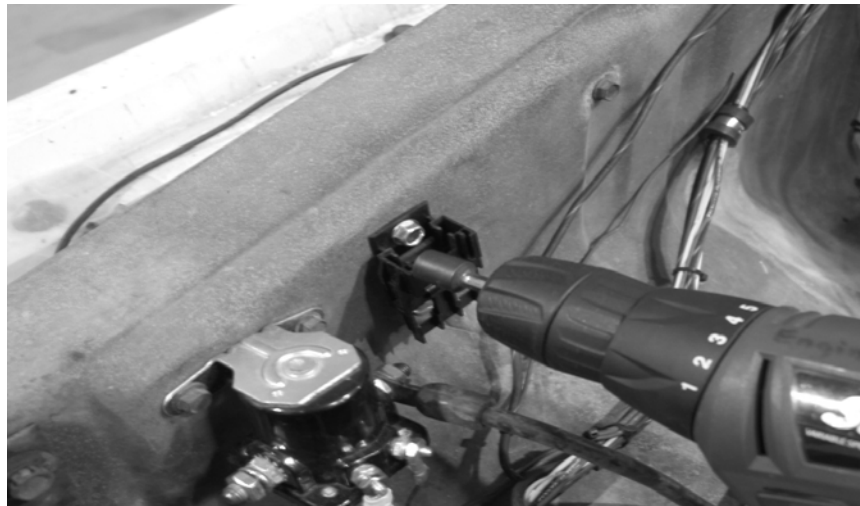

Figure 7-6 Installing the Maxi Fuse Holder '73-'77 Model

7.1.6 Using the provided ring terminals connect the PASSENGER SIDE SECTION black/yellow wire #916 to one side of Maxi Fuse Base. Using the remaining portion of wire #916 connect the other side of the Maxi Fuse Base to the Battery side of the starter solenoid. **See Figure 7-7.**

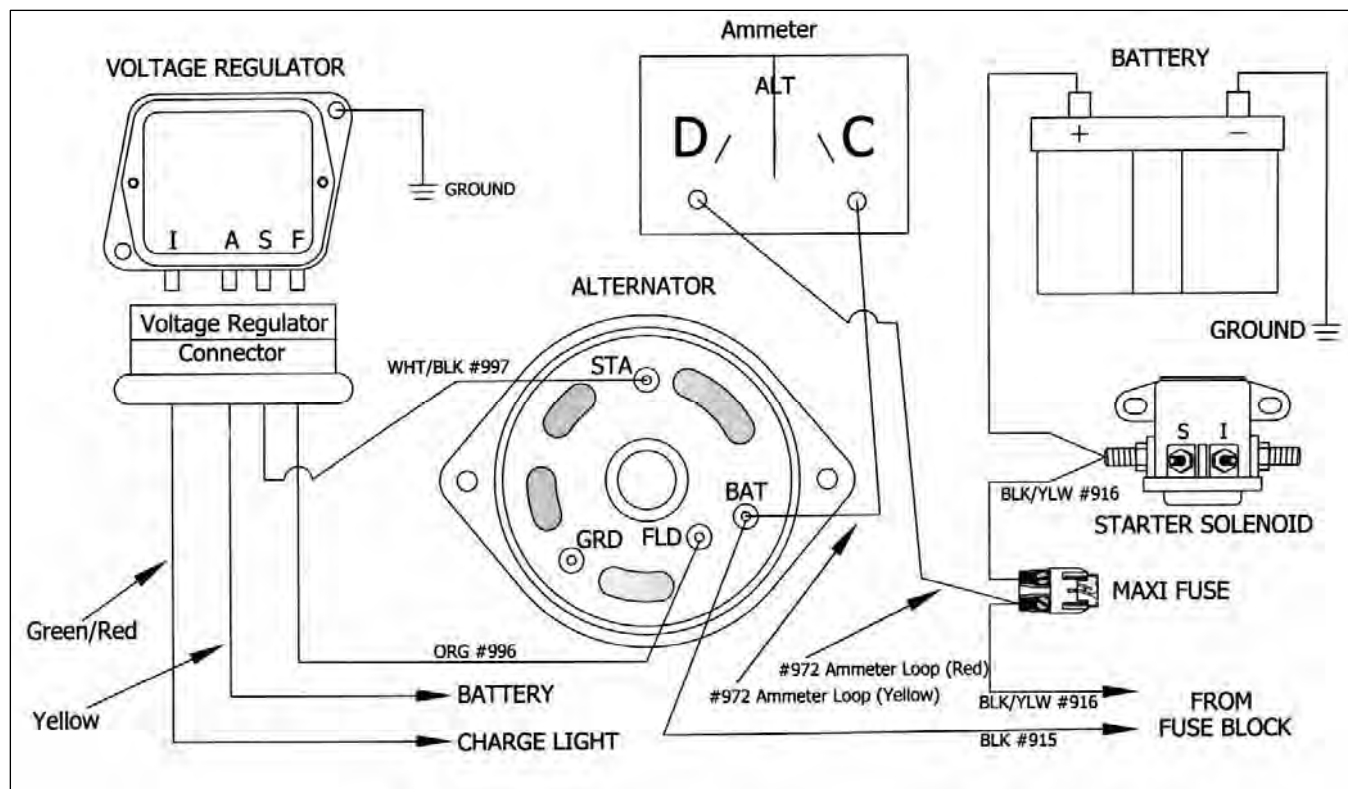

Figure 7-7 Alternator/Regulator/Solenoid Connections

7.2 High Amperage Alternator Kit

7.2.1 If an alternator with an output of more than 65 amps is being installed, a Painless High Amperage Alternator Kit, **Painless P/N 30709**, will need to be purchased.

7.3 Engine Section – Points and Electronic Style Ignition Systems

Points: Steps 7.3.1 thru 7.3.3 and Figure 7-8

Electronic: 7.3.4 and Figure 7-9

- 7.3.1** Connect ENGINE SECTION wire red/green #920 to one side of the ballast resistor. Using the remainder cut off of red/green #920; connect the other side of the ballast resistor to the positive post on the ignition coil. A ballast resistor is included in the parts kit. Be sure to mount it away from anything sensitive to heat, because it gets very hot. **See Figure 7-8.**
Note: During normal operation the ballast resistor gets very hot, be sure to mount it away from any other wiring.
- 7.3.2** Connect ENGINE SECTION wire brown #970 directly to the positive post on the ignition coil or the coil feed side on the ballast resistor. The other end is to be connected to the "I" terminal on the starter solenoid. **See Figure 7-8.**
- 7.3.3** Connect ENGINE SECTION wire red/blue #919 to the "S" terminal on the starter solenoid. If using a Tachometer, connect ENGINE SECTION wire red/yellow #923 to the negative side of the ignition coil. **See Figure 7-8**
- 7.3.4** If the truck has a Ford Duraspark II Electronic Ignition system refer to **Figure 7-9** for wiring details. If the terminals in the plugs on the stock Duraspark Ignition harness are corroded or the wires are frayed, then the harness will need to be replaced with **Painless Wiring P/N 30812.**

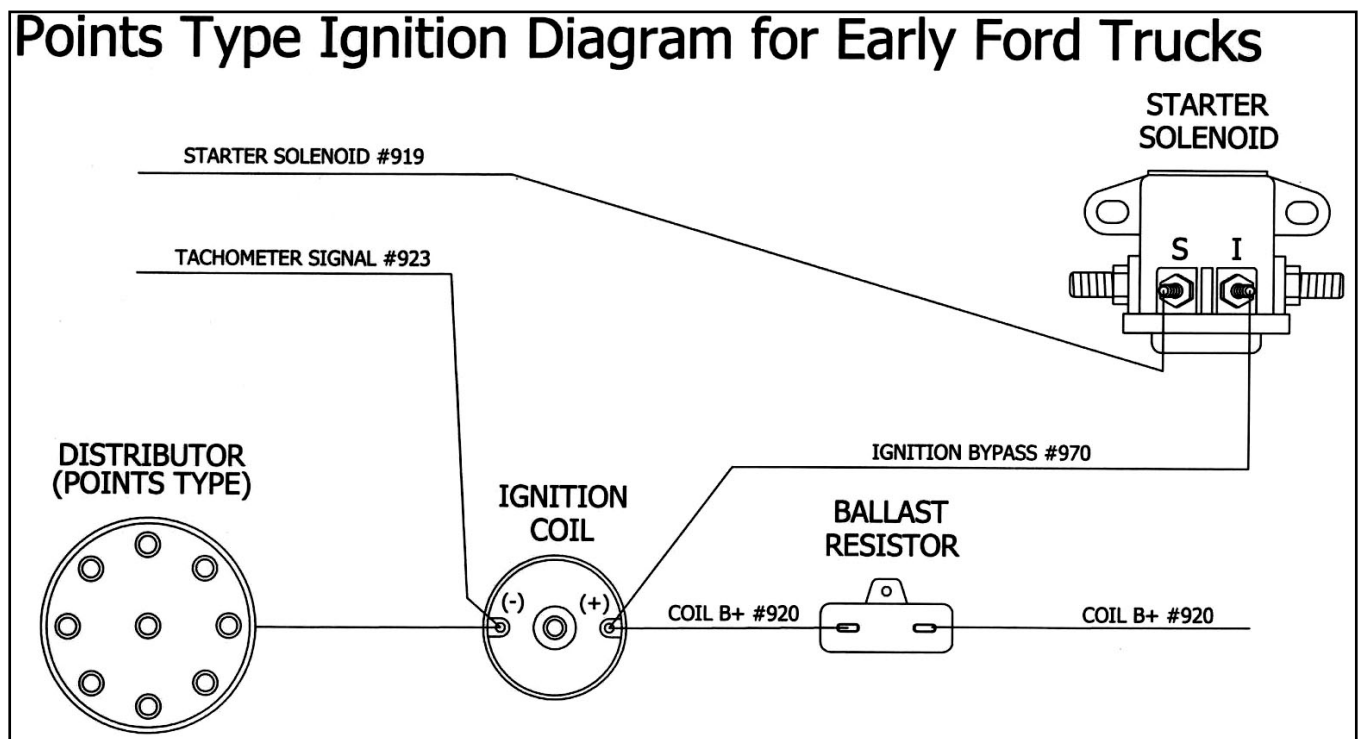

Figure 7-8 Points Style Ignition Diagram

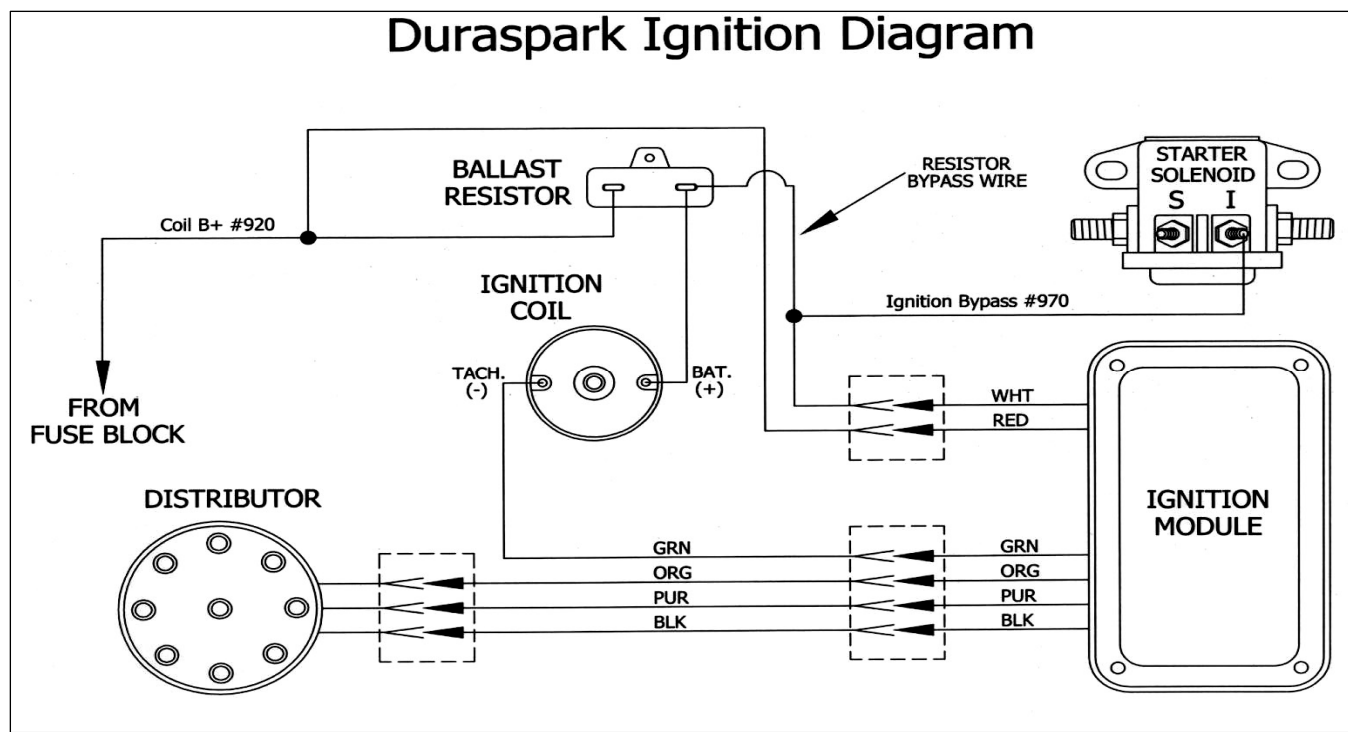

Figure 7-9 Ford Duraspark II Systems (Ford Electronic Ignition)

- 7.3.5** Connect ENGINE SECTION Temperature Sending Unit red/white wire #921 to the engine temperature sending unit. Connect ENGINE SECTION Oil Pressure Sending Unit white/red wire #922 to the engine oil pressure sending unit. Connect the ENGINE SECTION Electric Choke B+ white/blue wire #954 to the electric choke.
- 7.3.6** Neutral Safety/Backup Light Switch wire #'s 958, 956 and 919 (2 wires) all breakout from the firewall in the UNDER DASH SECTION. #958 is the power source to the switch for the backup lights and #956 is the wire connected to the actual bulbs. The red/blue wire #919 provides the start signal to the Neutral Safety switch. Then the other red/blue wire #919 carries the start signal from the Neutral Safety switch to the Starter Solenoid. Neither of the #919 wires are polarity specific. **See Figure 7-10.**
- 7.3.7** If the truck being rewired had a standard transmission, wire #'s 956 and 958 will need to be routed thru the firewall and to the backup light switch on the shift linkage. **See Figure 7-11. Important:** Early Standard Transmission Trucks **do not** have neutral safety switches. This means the two #919 wires in the same breakout as #956 and #958 will need to be connected together with a butt splice.

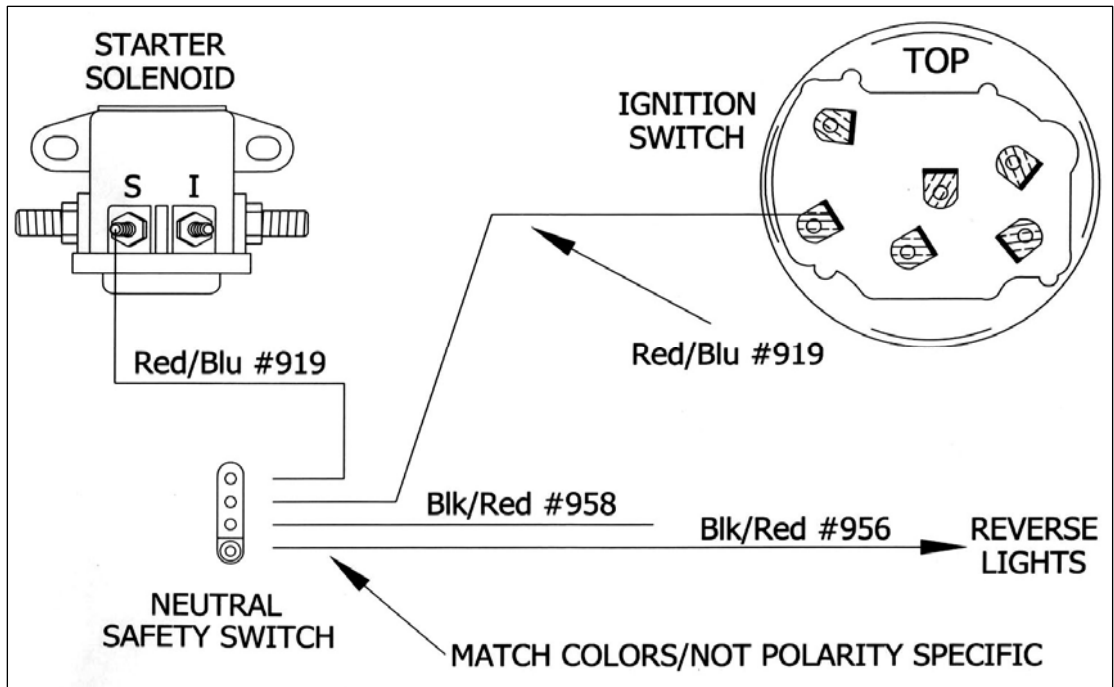

Figure 7-10 NEUTRAL SAFETY SWITCH (All Models with Auto Trans)

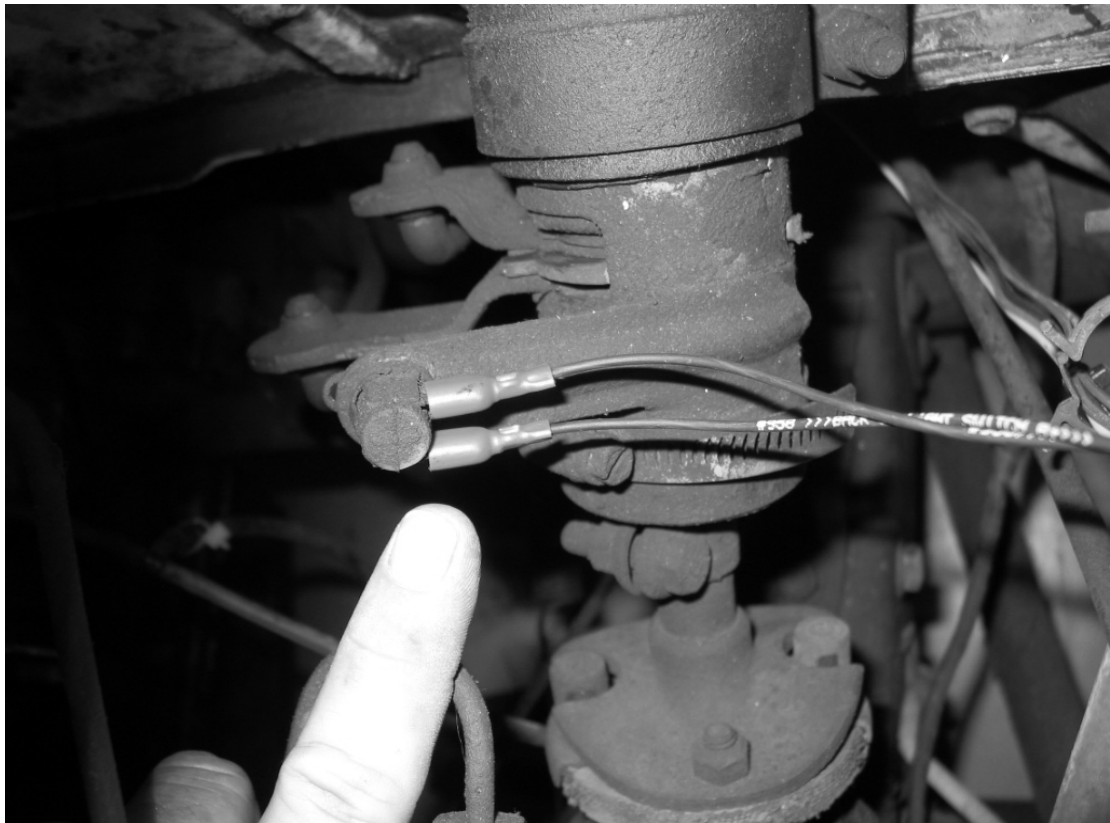

Figure 7-11 NEUTRAL SAFETY SWITCH (All Models with Standard Trans)

7.4 Headlights/Front Turn Signals/Side Markers

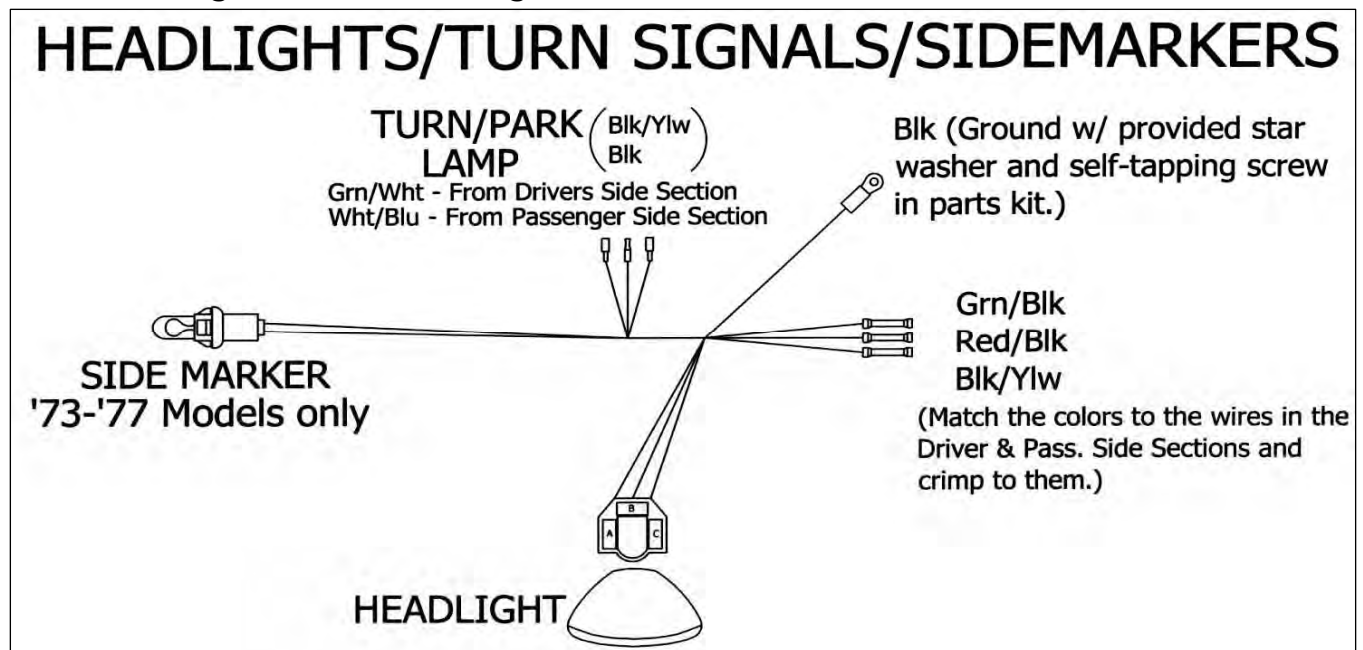

Figure 7-12 Headlights/Turn Signals/Side Markers '73-'77 Models

- 7.4.1** Locate the Passenger and Driver Side Headlight Pigtails in the parts kit. Install one of the Headlight Pigtails onto each headlight. Feed the wires from each pigtail through the core support and down to the back of each turn signal in the grill and in each wheel well. Using **Figure 7-12** connect the headlight pigtails to the Passenger and Driver Side Sections. **Note: '67-'72 Model Trucks use the headlight pigtails with the headlight connectors only. On these trucks the turn signal will be connected directly to the harness without a pigtail.**
- 7.4.2** For trucks equipped with a Wiper Washer Motor, wire #998 Wiper Washer Motor (Light Green) is the power wire for the washer pump motor. It's in the Driver Side Section under the hood. Connect it to the lighter colored wire side of the pumps wires and ground the other to the inner fender. **See Figure 7-12.1.**
- 7.4.3** Connect wire #968 Prop. Valve Brake Switch (Purple/White) to the proportioning valve grounding wire. Either may be used if there are two wires. **See 7-12.2.**



Figure 7-12.1 Washer Motor (Optional)



Figure 7-12.2 Proportioning Valve

7.5 Rear Light Section

7.5.1 The TAIL SECTION consists of wires for: Taillights, Stoplights, Left and Right Turn Signals, Side Marker Lights, Backup Lights, License Plate Lights, and the Fuel Tank Sending Unit. **Connect the wires from the harness directly to the light sockets.** See Figure 7-13. **Note: '67-'72 Models DO NOT use the Tail Ground Harnesses. The grounds for the lamps are provided through the stamped steel tail light housings.**

7.5.2 On '67-'72 Model trucks with the gas tank behind the bench seat, it will be necessary to remove #939 Orange from the Tail Section breakout, pull it through the firewall, up the drivers side A-Pillar and down to the Fuel Tank Sending Unit.

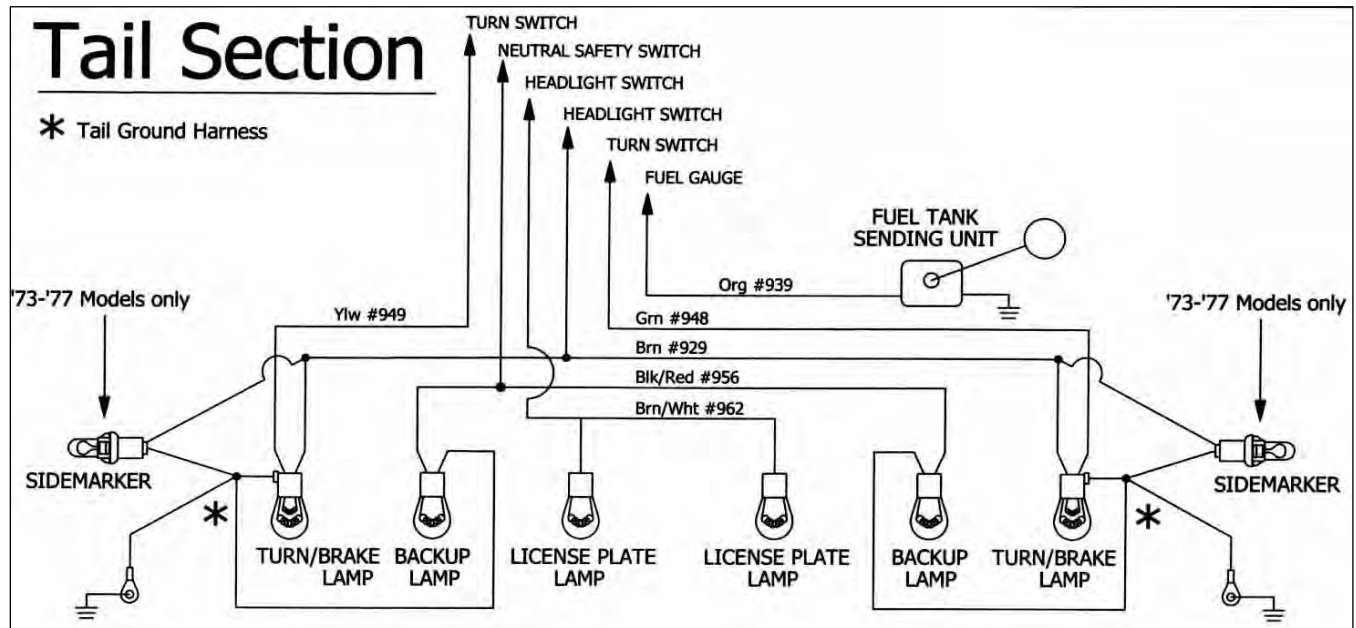

Figure 7-13 Tail Section for all Model Trucks

7.6 Under Dash Section – Turn Signal Switch Connection

7.6.1 When wiring 1967-1972 Model Trucks the original Turn Signal Switch Connector will plug directly into the new Turn Signal Connector in the Under Dash Section. **See Figure 7-14. Note: If using a Tachometer, notice the TACH signal wire is in the Turn Signal breakout of the harness.**

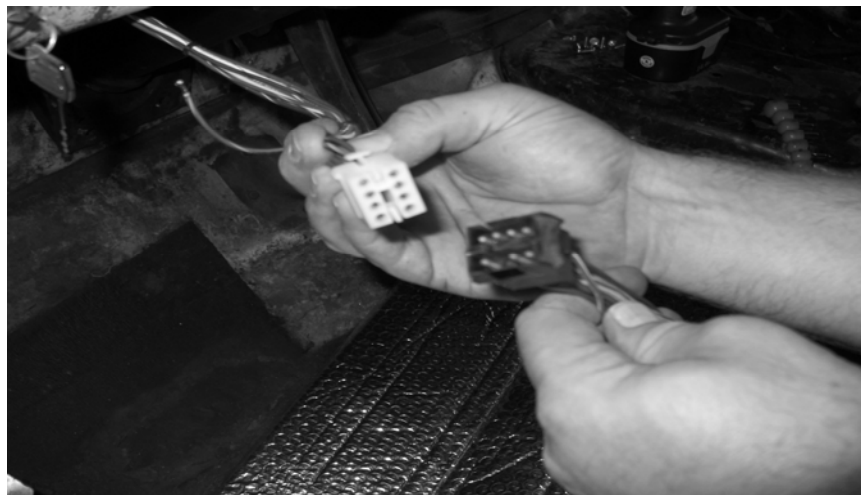

Figure 7-14 Early Model ('67-'72) Turn Signal Connection

7.6.2 On 1973-1977 Model Trucks it will be necessary to use the provided "Late Model Turn Pigtail", when connecting the turn signal switch. The connectors for the late model switches ARE NOT available and are therefore not included in this kit. Both the connector and the "RED" terminal lock on the inside will need to be reused. Using a small flat screwdriver and/or a small pair of needle nose pliers, gently pry out the lock and remove the original wires. The pigtail wire colors match the original colors from the old harness. **See Figure 7-15. Note: If using a Tachometer, notice the signal wire for it is in the Turn Signal breakout of the harness.**

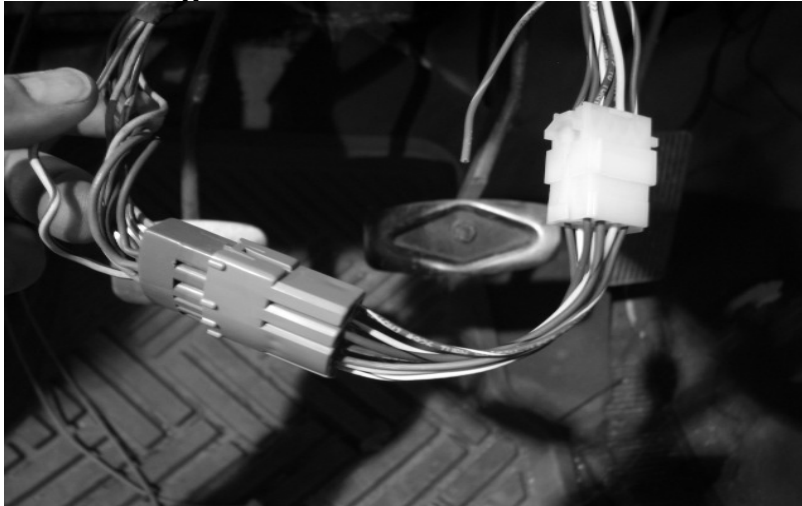

Figure 7-15 Late Model Turn Pigtail ('73-'77)

7.7 Under Dash Section – Ignition Switch (All Models)

7.7.1 Connect the IGNITION SWITCH wires to the new supplied Ignition Switch as illustrated in **Figure 7-16**. This switch is **ONLY SUPPLIED in P/N 10118**. **On 1967-1972 Model trucks it will be necessary to cut the Ignition Switch wires to fit. They are extra long to accommodate the later model truck dashes. The four spade terminals required are included in the parts kit. See Figure 7-16 and 7-17.**

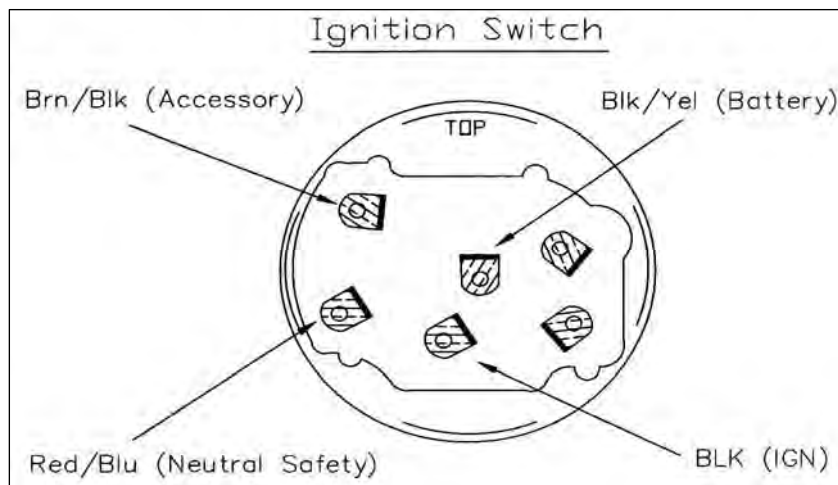

Figure 7-16 Ignition Switch w/Painless Harness P/N 10118



Figure 7-17 Ignition Switch Connections

7.7.2 Ignition Switch Removal and Installation

The following pictures show the step by step removal and installation of Ignition Switches in Ford trucks from 1967-1977.



Step 1 – Turn Switch to **ACC. POSITION**



Step 2 – Bend open a paper clip and insert it into the small hole above the key. Notice the spring loaded pin.



Step 3 – Turn Switch CCW one more click.

Step 4 – Pull the Lock Tumbler out of Switch

Step 5 - To reinstall the Ignition Switch Tumbler push the Lock Tumbler w/Key into the Switch and turn clockwise.

7.8 Under Dash Section - Headlight Switch

- 7.8.1** Connect the HEADLIGHT SWITCH wires as illustrated in **Figure 7-18**. After completing the installation of the Headlight Switch wires locate the DASH GROUND #969 wire, which is directly above the steering column in the main body of the harness and connect it to the chassis ground screw behind the gauge cluster.

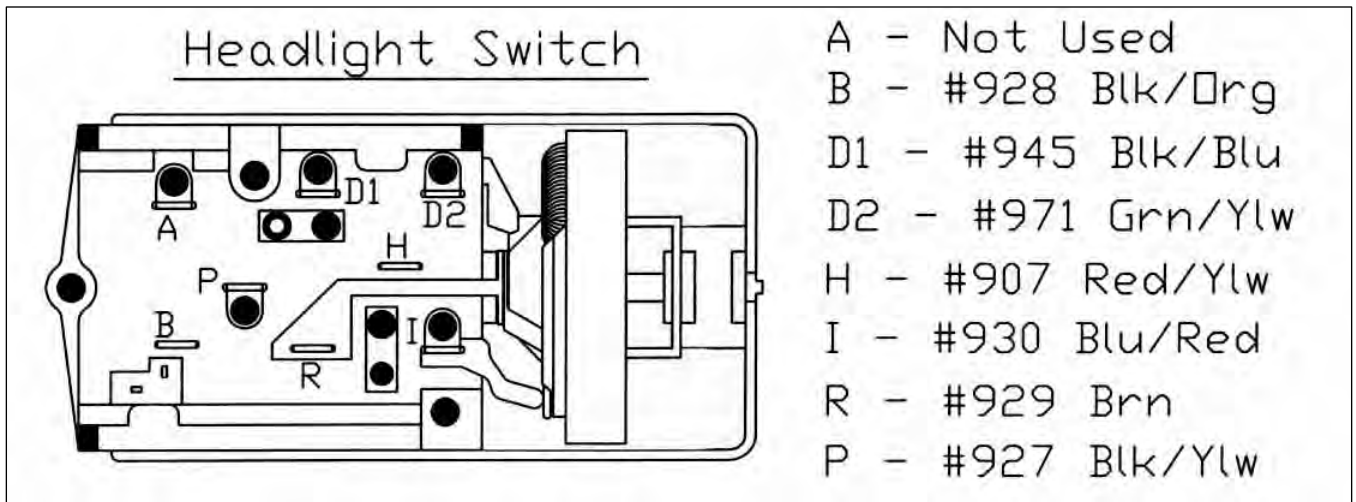

Figure 7-18 Headlight Switch Connections (All Models)

7.9 Under Dash Section - Brake Lights Switch (All Models)

- 7.9.1** Route the BRAKE SWITCH wires #917 Brake Switch B+ (Red) and #918 Brake Switch Output (Red/Black) over the steering column and down to the Brake Switch located on the brake pedal. Leave enough slack in the wires to allow for the brake pedal movement. These wires **are not** polarity specific, in other words it does not matter which wires goes onto each side of the switch. See Figure 7-19.



Figure 7-19 Brake Switch ('67-'77)

7.10 Under Dash Section - Wiper Switch

- 7.10.1** All 1967-1977 Model Ford Trucks use the same Wiper Switch. The original connector for these wiper switches is no longer available, so the original one must be reused. Connect the ORANGE, ORANGE/WHITE, and #998 LIGHT GREEN wires as shown in Figures 7-20 and 7-21. The RED, WHITE, BLACK and BLUE wires all come from the wiper motor and are in the original connector. The ORANGE wire is also in the original connector and supplies power to the wiper switch and to the motor.

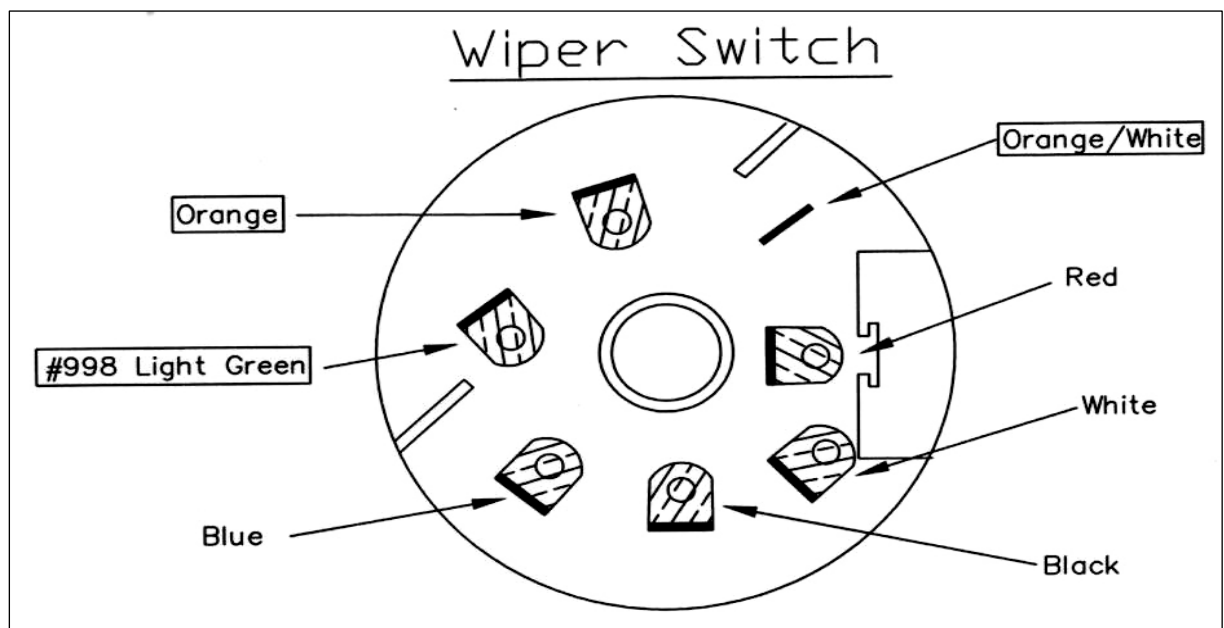

Figure 7-20 Wiper Switch Connections (All Models)



Figure 7-21 Wiper Switch w/wires connected

7.11 Under Dash Section – Dimmer Switch

- 7.11.1** Locate the Dimmer Switch wires: #907 Red/Yellow, #908 Green/Black and #909 Red/Black and route them between the kick panel and the safety brake pedal bracket and down to the Dimmer Switch. **See Figure 7-22.**
- 7.11.2** Next connect the wires to the Dimmer Switch. **See Figure 7-23.**



Figure 7-22 Routing the Dimmer Switch Wires

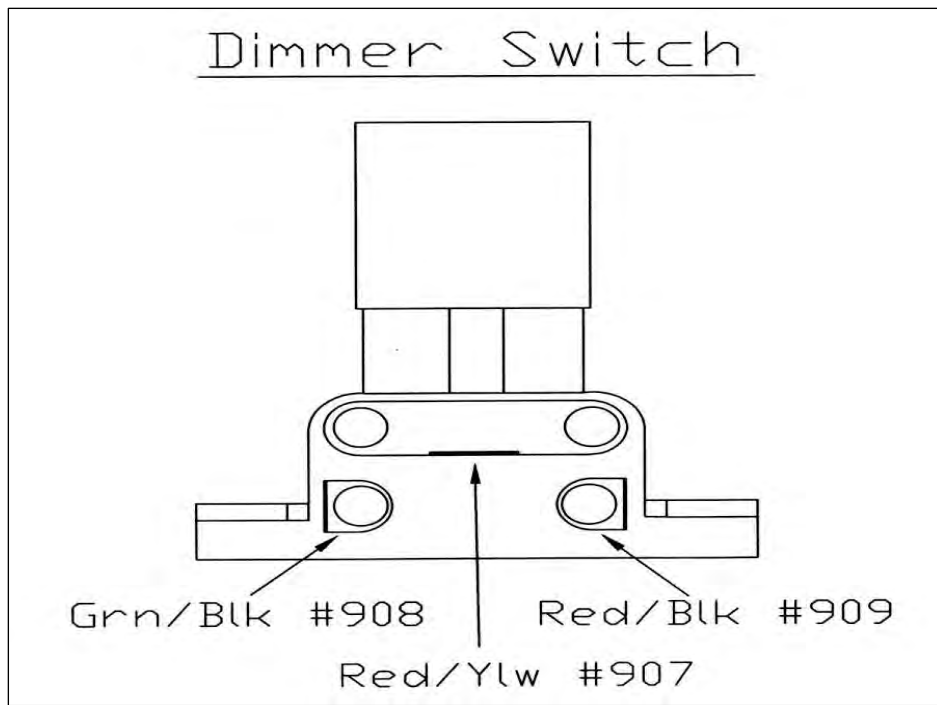

Figure 7-23 Dimmer Switch Connections (All Models)

7.12 Under Dash Section – Cargo Light Switch (Option on some Models)

- 7.12.1** Locate #993 Light Green/Yellow (Cargo Lamp Switch Power) wire and #994 Light Green/Yellow (Cargo Lamp) wire. Connect to the Cargo Lamp Switch pigtail with one bullet male connector and one female bullet connector. (This switch is not polarity specific) **See Figure 7-24.**

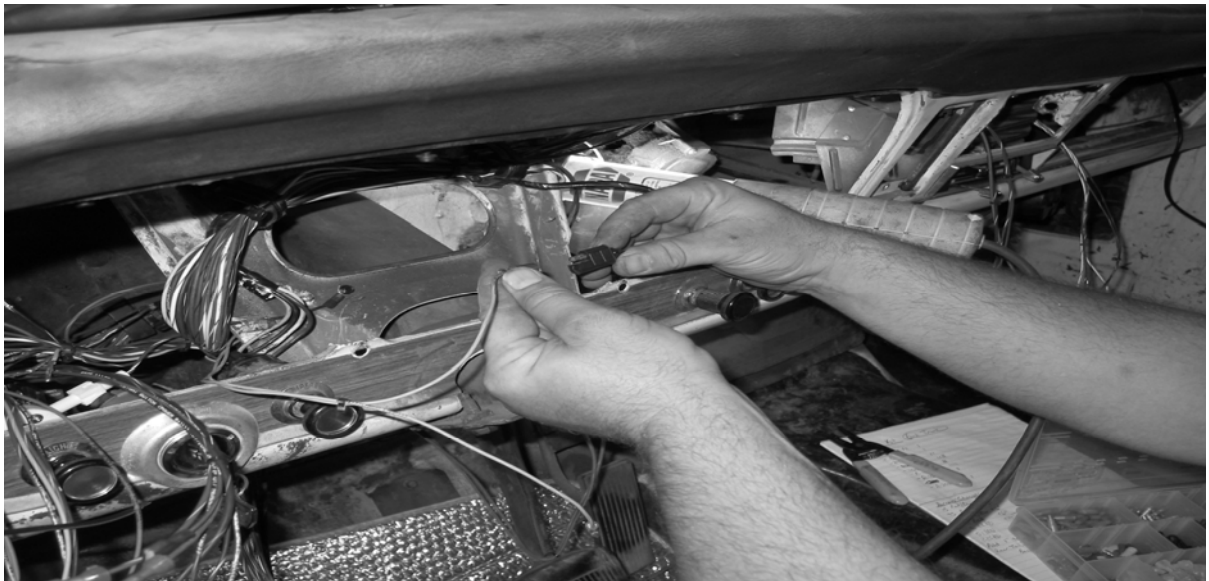

Figure 7-24 Cargo Light Connections

- 7.12.2** Locate and connect wire #903 Blue/White to the center post on the back of the Cigar Lighter.

7.13 Under Dash Section – Dome Light

- 7.13.1** On 1967-1972 Models only, feed both the passengers side and drivers side door jamb switch wires #945 Black/Blue and #971 Green/Yellow over to each windshield pillar. Using four red butt connectors from the parts kit connect each wire to its appropriate door jamb switch wires. The colors of these wires may match, but they are not polarity specific. **See Figure 7-27 for '67-'72 models and Figure 7-28 for '73-'77 models.**

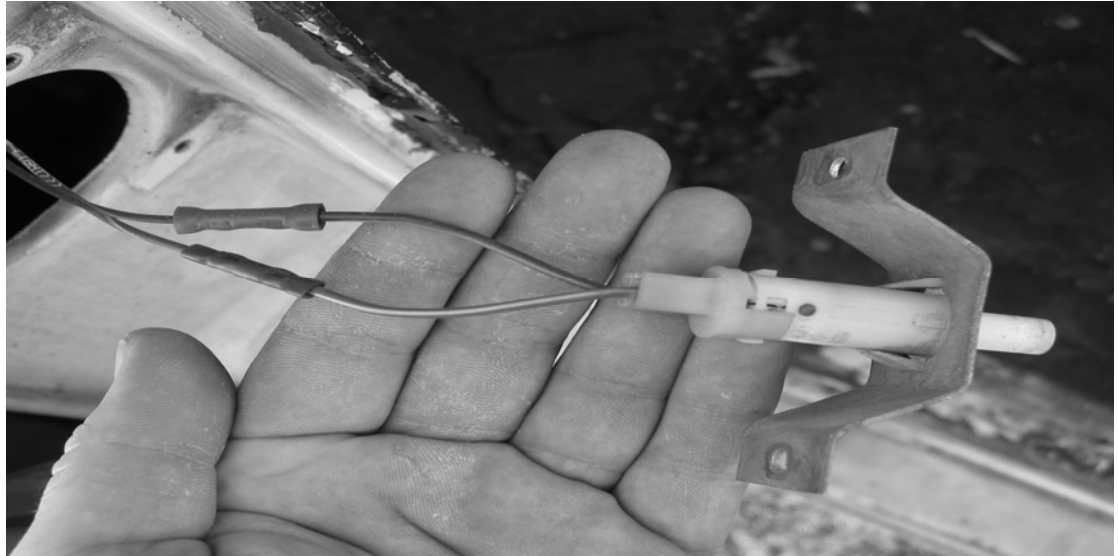

Figure 7-25 Door Jamb Switches – 1967-1972 Models



Figure 7-26 Door Jamb Switches – 1973-1977 Models

- 7.13.2** Next locate wire #971 >>> TO DOME LIGHT >>>, feed it up through the A-pillar and up to the dome light. **Note: If the original wire is still in perfect working condition, it may be easier to reuse the original dome light wire. See Figure 28.**

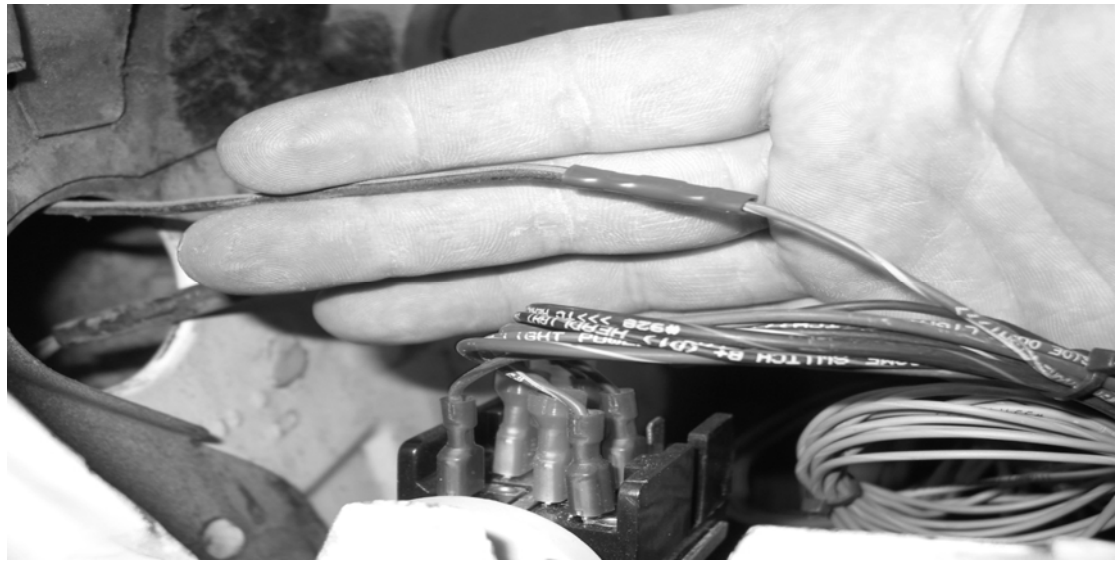

Figure 7-27 Dome Light Power Wire (All Models)

7.14 Under Dash Section – Air Conditioning/Heater Configurations

7.14.1 For all 1967-1972 Ford Trucks with a factory heater and no Air Conditioning, locate the Heater Harness in the parts kit and install as shown below in **Figure 7-28**.

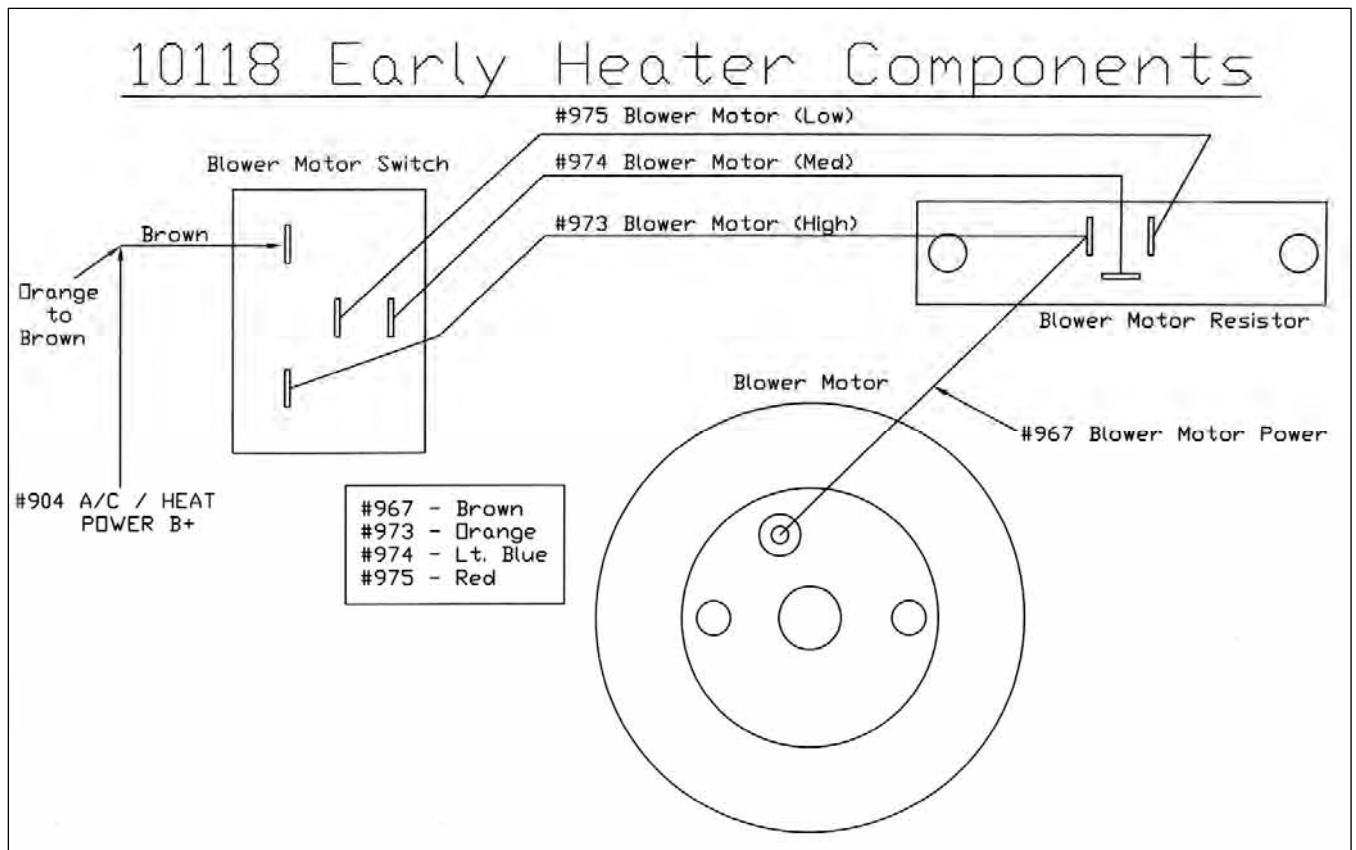

Figure 7-28 Heater Harness Installation for 1967-1972 years only.

7.14.2 For all 1967-1972 Ford Trucks with **Factory Air Conditioning (Not Dealer Installed)** call 817-560-TECH.

7.14.3 For all 1973-1977 Ford Trucks with a factory heater and no Air Conditioning, locate the Heater Harness in the parts kit and install as shown below in **Figure 7-30**.

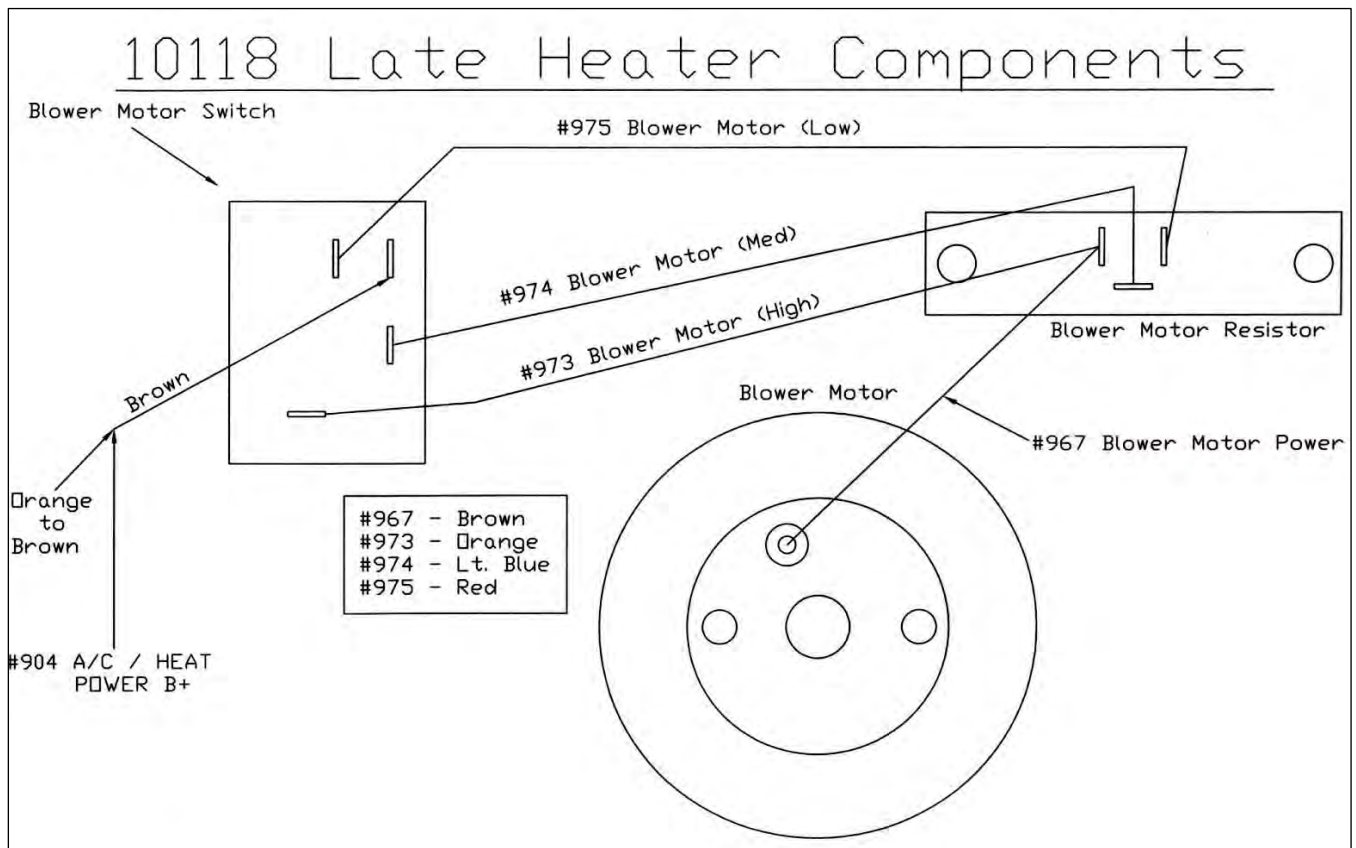

Figure 7-30 Heater Harness Installation for 1973-1977 years only.

7.14.4 For all 1973-1977 Ford Trucks with a factory Heater and Air Conditioning, locate the Heater Harness and A/C Relay Harness in the parts kit and install as shown below in **Figure 7-31**.

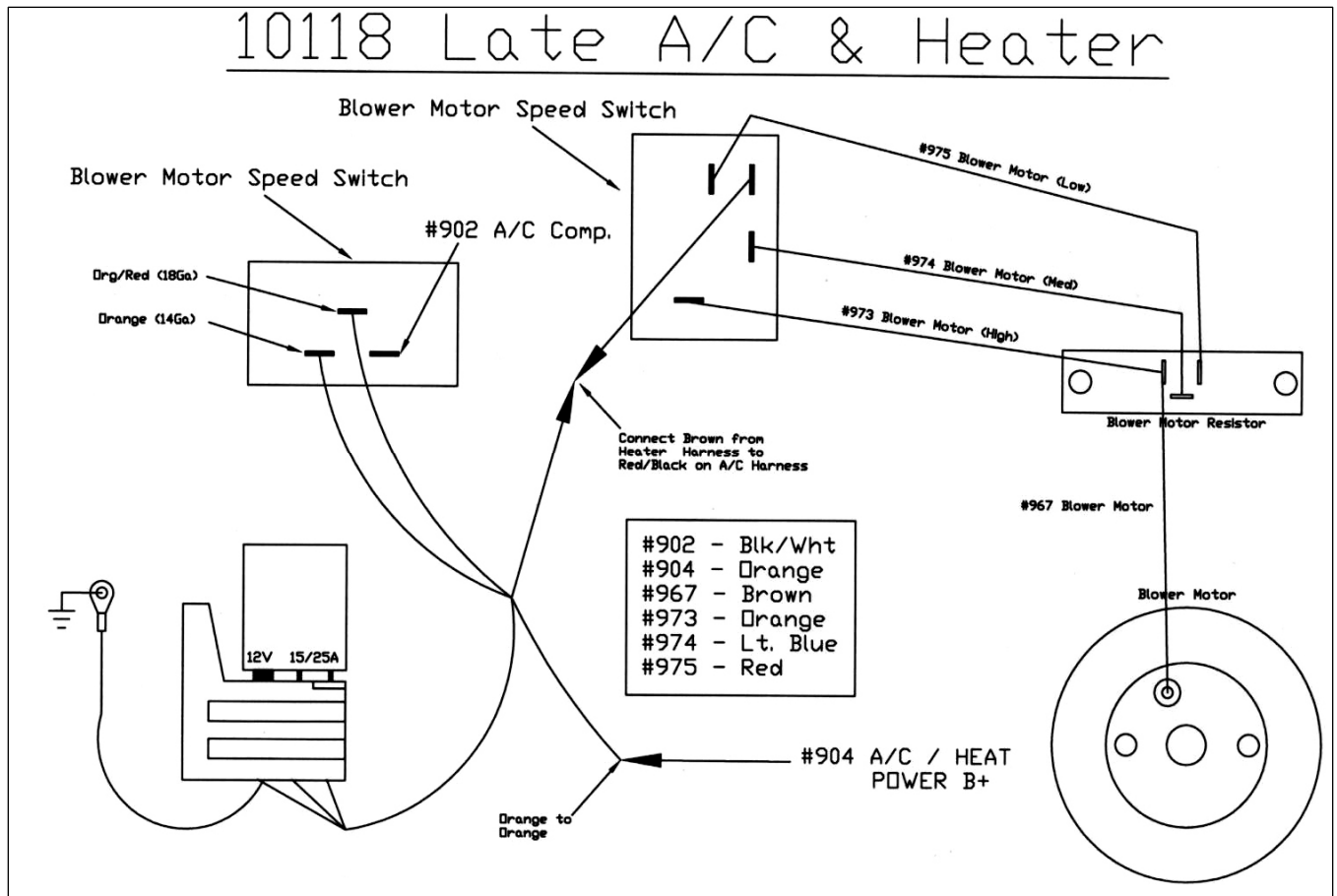

Figure 7-31 A/C - Heater Harness Installation for 1973-1977 years only

7.15 Under Dash Section – Hazard Switch

7.15.1 On early model Ford Trucks (1967-1972) the Hazard Flasher Switch is located in the glove compartment. On these trucks, route wires #951, #925, #926 and #918 over to the glove compartment Hazard Switch. **See Figures 7-25 & 7-26.** On later model Ford Trucks (1973-1977), all the connections for the Hazard Circuit are done thru the Turn Signal Switch Connector. On these trucks the Hazard Switch is on the column. **Note: On some early model trucks the Hazard Switch is on the dash, next to the cigarette lighter. For these models follow the same pin-out in Figure 7-33.**

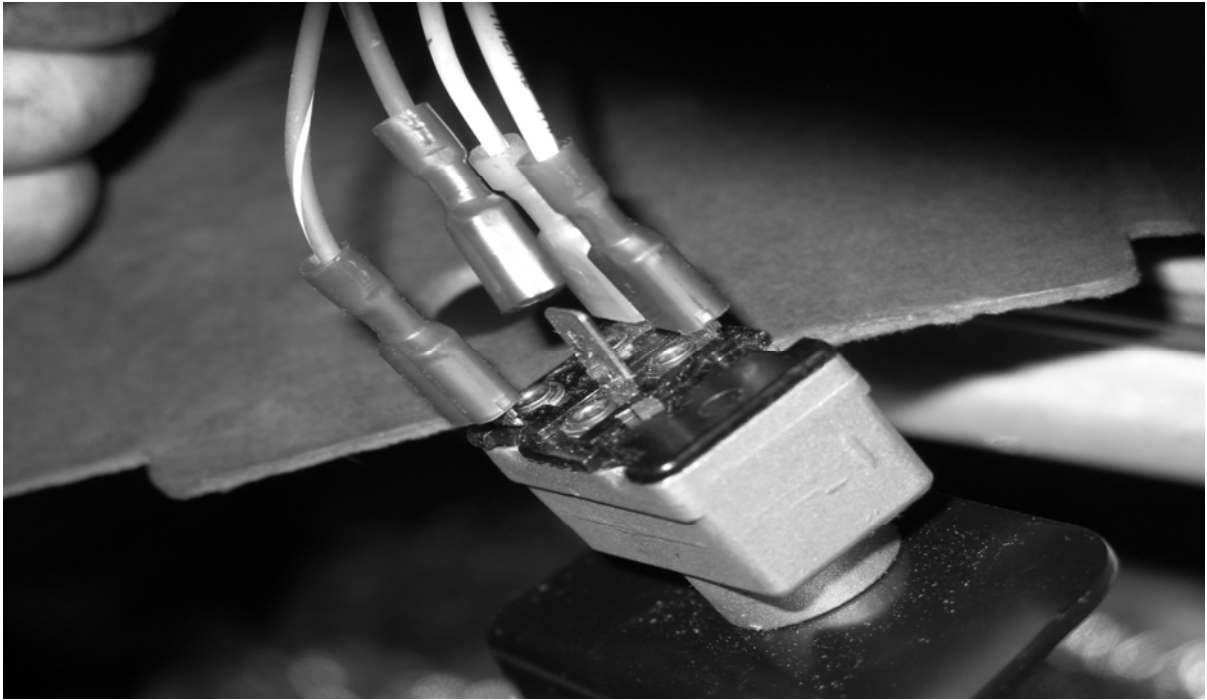

Figure 7-32 Hazard Switch (Early Model Trucks 1967-1972)

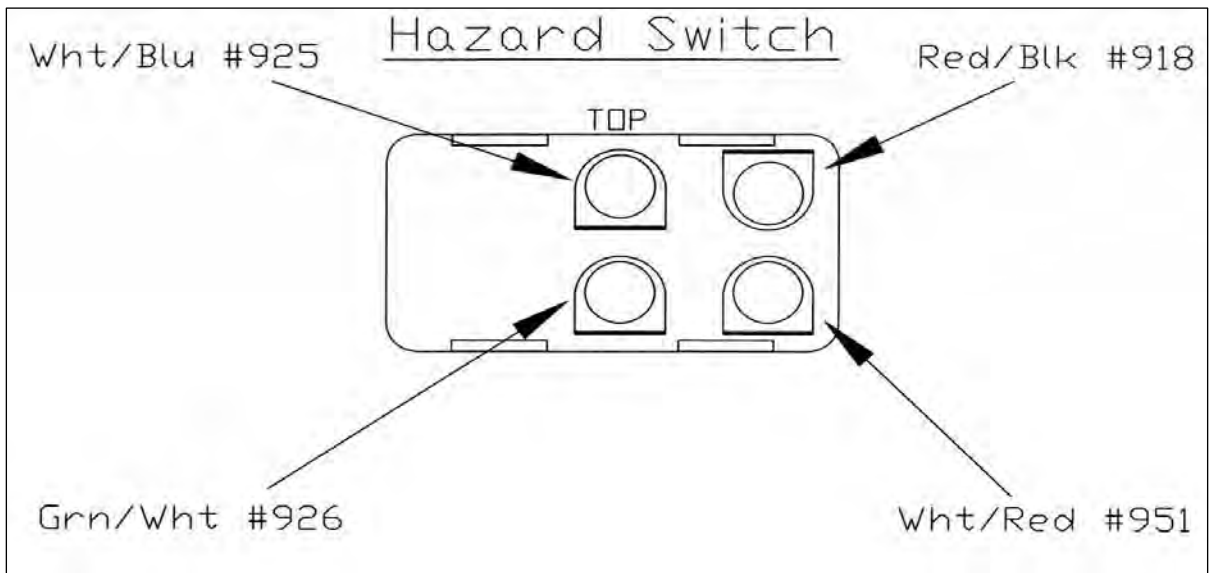

Figure 7-33 Hazard Switch Wire Connections (Early Model Trucks 1967-1977)

Please Note: The following information on 1967 – 1977 Ford Truck Instrument Clusters is based on individual clusters from each year of truck. The year of manufacture was derived from the date code located in the door jamb on the driver's side of the trucks. VERY IMPORTANT: It is the responsibility of the end user of this harness to be sure and "double check" for the correct pin out and application of the cluster pigtails provided. At the time of design, Painless purchased one gauge cluster from every year of coverage this harness provides. This does not mean other gauge combinations do not exist, and when such occurs it will be necessary for the end user to "trace" the ribbons of copper in the printed circuit on the back of the cluster being used to their exact gauge or light. This harness does not support Fuel Economy or Seat Belt Lights.

7.16 Gauge Cluster Section – 1967-1969 Trucks only.

- 7.16.1** Locate the "Early Cluster Harness" in the kit. This harness will connect to the back of a 1967, 1968 or 1969 Dash Cluster only. Some clusters have gauges for Fuel Level and Temperature only. See Figure 7-34. Other clusters have all four gauges. On the early stamped steel Ford clusters the wire color of each connection is stamped into the metal.
- 7.16.2** After removing the original harness, carefully lay the new cluster harness over the back of the cluster as shown. Now read the wire designations by each (holes – for lights) and (threaded studs – for sockets). Connect the harness as shown in Figure 7-34. **NOTE: If the cluster being wired has an ammeter and not a charge light, the bulb and socket for the charge light must be cut off and the wires spliced together. If this step is skipped the charging system will not work.**

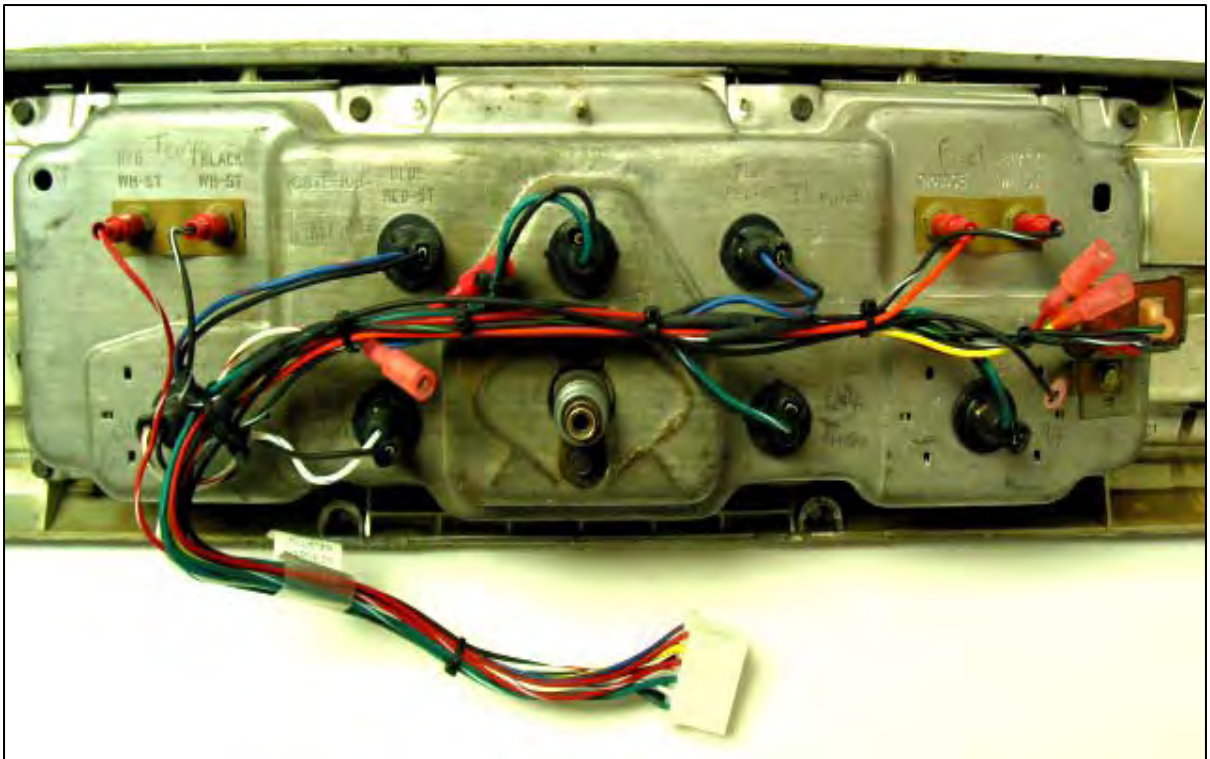

Figure 7-34 1967 thru 1969 Models - Cluster Harness

7.17 Gauge Cluster Section – 1970-1974 Trucks

- 7.17.1** For the years 1970 thru 1974 locate the '70 – '74 Cluster Pigtail in the harness kit. The connectors from 1970, 1971, 1973 and 1974 Ford trucks are all the same for the gauge clusters. Only 1972 Ford trucks have their own individual connector. The original connector for the gauge cluster must be reused on all trucks. **See Figures 7-35 thru 7-38. Locate the year of the truck being rewired and follow the diagram for the proper pin out.**

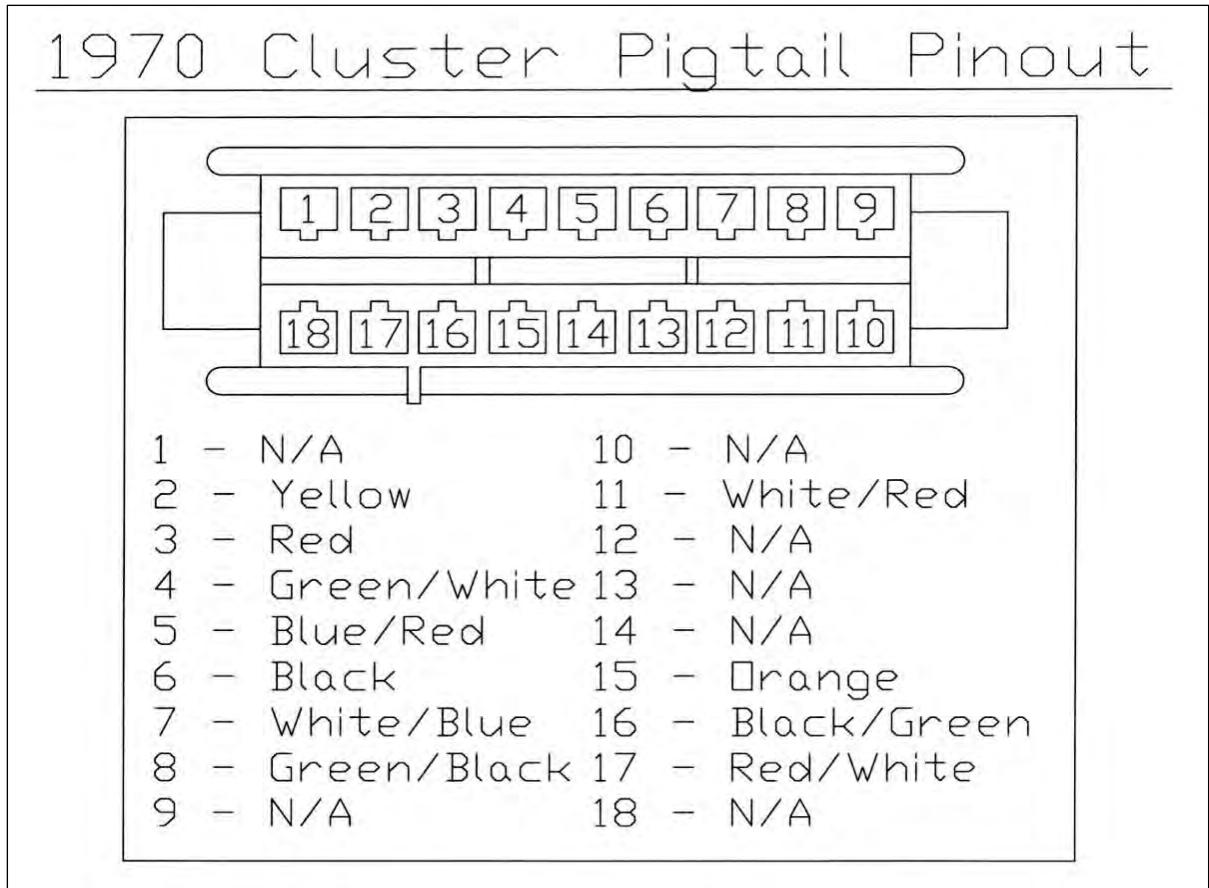

Figure 7-35 1970 Cluster Pigtail Pinout

1971 Cluster Pigtail Pinout

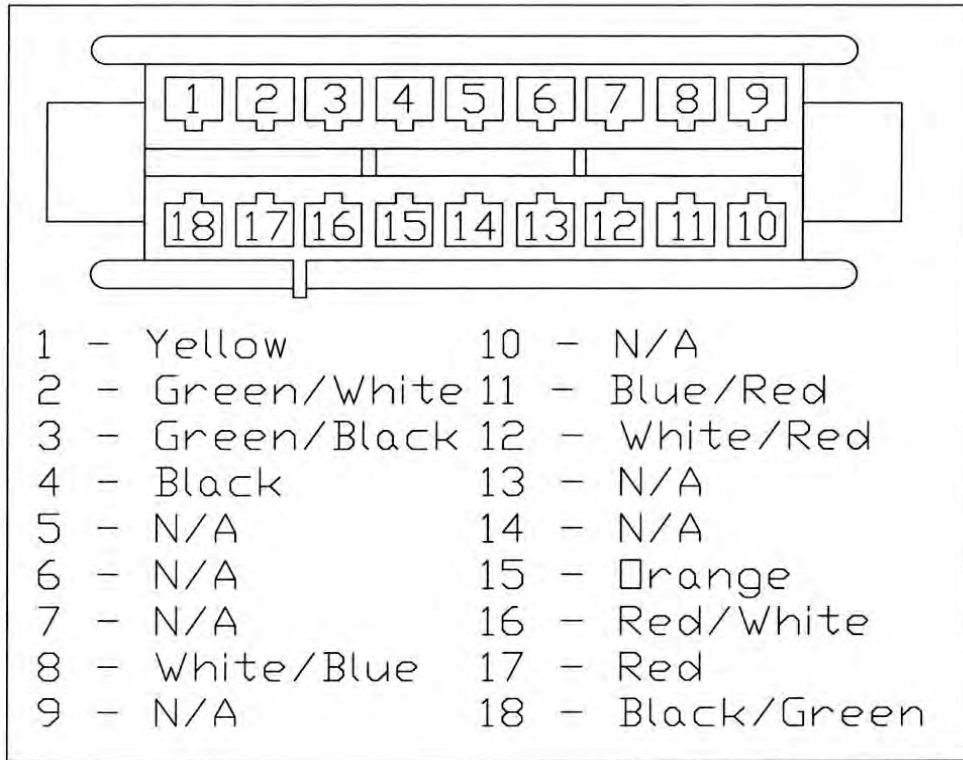

Figure 7-36 1971 (AND SOME 1972 MODELS) Cluster Pigtail Pinout

1972 Cluster Pigtail Pinout

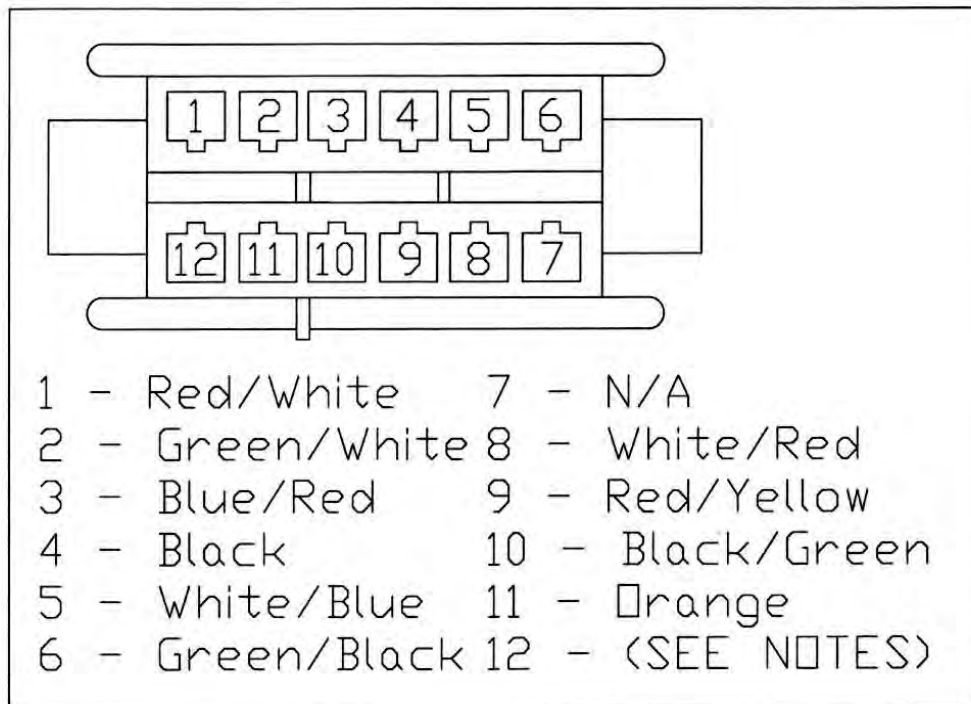

Figure 7-37 1972 Cluster Pigtail Pinout (If 18 Pin Connector use Figure 7-36)

7.17.2 NOTES: For 1972 Models ONLY! On the 1970 – 1974 Cluster Pigtail, remove the Green/Red wire from the #2 cavity on the white connector and install the single Green/Red wire with the Label “Green/Red 1972 Only” on it. Carefully tape up and stow the removed wire and be absolutely sure to insulate it from a ground.

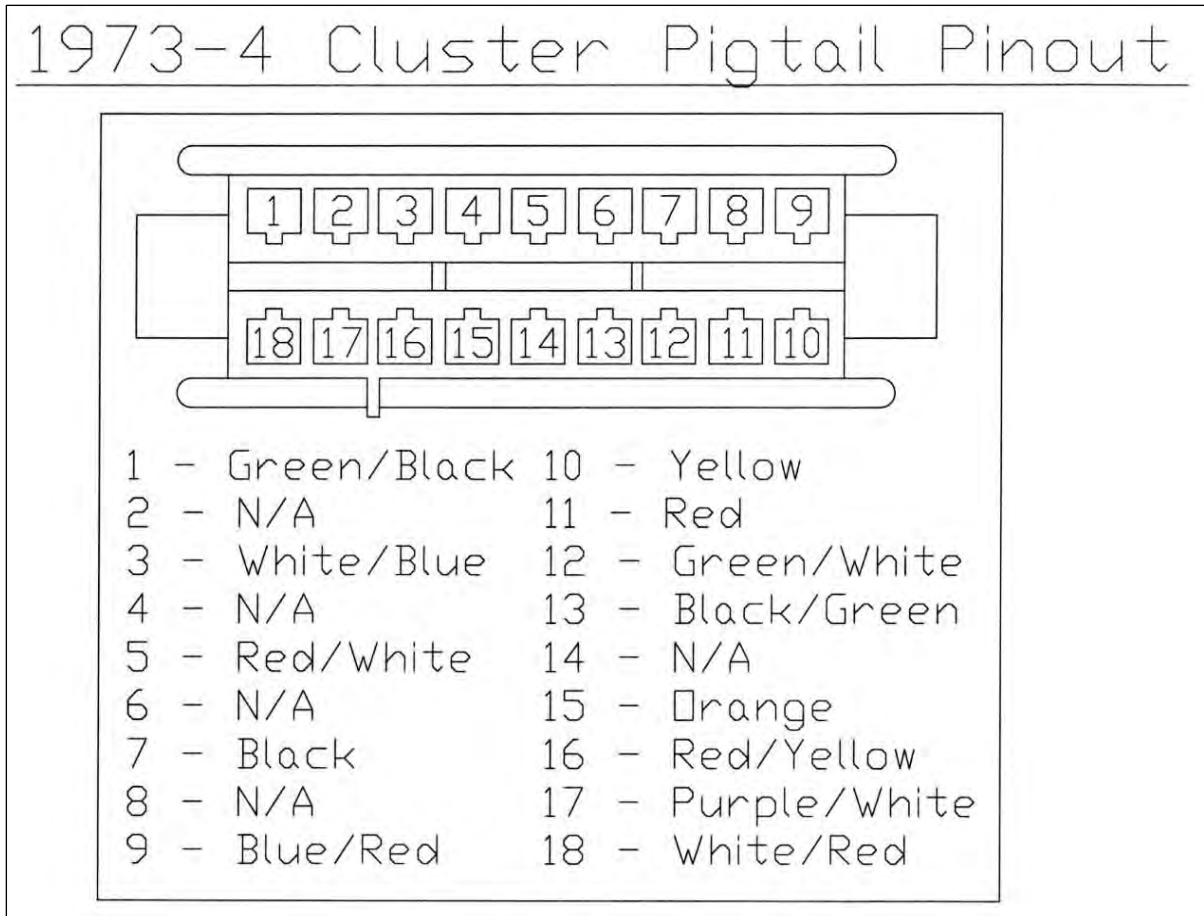

Figure 7-38 1973 - 1974 Cluster Pigtail Pinout

7.17.3 On 1973 and 1974 Clusters the Purple/White wire labeled “1970-74 Brake Light” must be installed into the #17 Connector Cavity and then connected to it’s mating connector on the main harness next to the Cluster Connector.

7.18 Gauge Cluster Section – 1975-1977 Trucks

- 7.18.1** For the years 1975 thru 1977 locate the '75 – '77 Cluster Pigtail in the harness kit. The gauge cluster connectors for 1975, 1976 and 1977 Ford trucks are all the same for the gauge clusters. **The original connector and terminals for the gauge cluster must be reused on all '75, '76' & '77 trucks.** NOTE: A small flat screwdriver may be used to remove the terminals from the original connectors. After removal, it is recommended to solder the old terminals to the new wires in the cluster pigtail. See **Figures 7-39 and 7-40 for the cluster pin outs. Locate the year of the gauge cluster being rewired and follow the diagram for the proper pin out.**

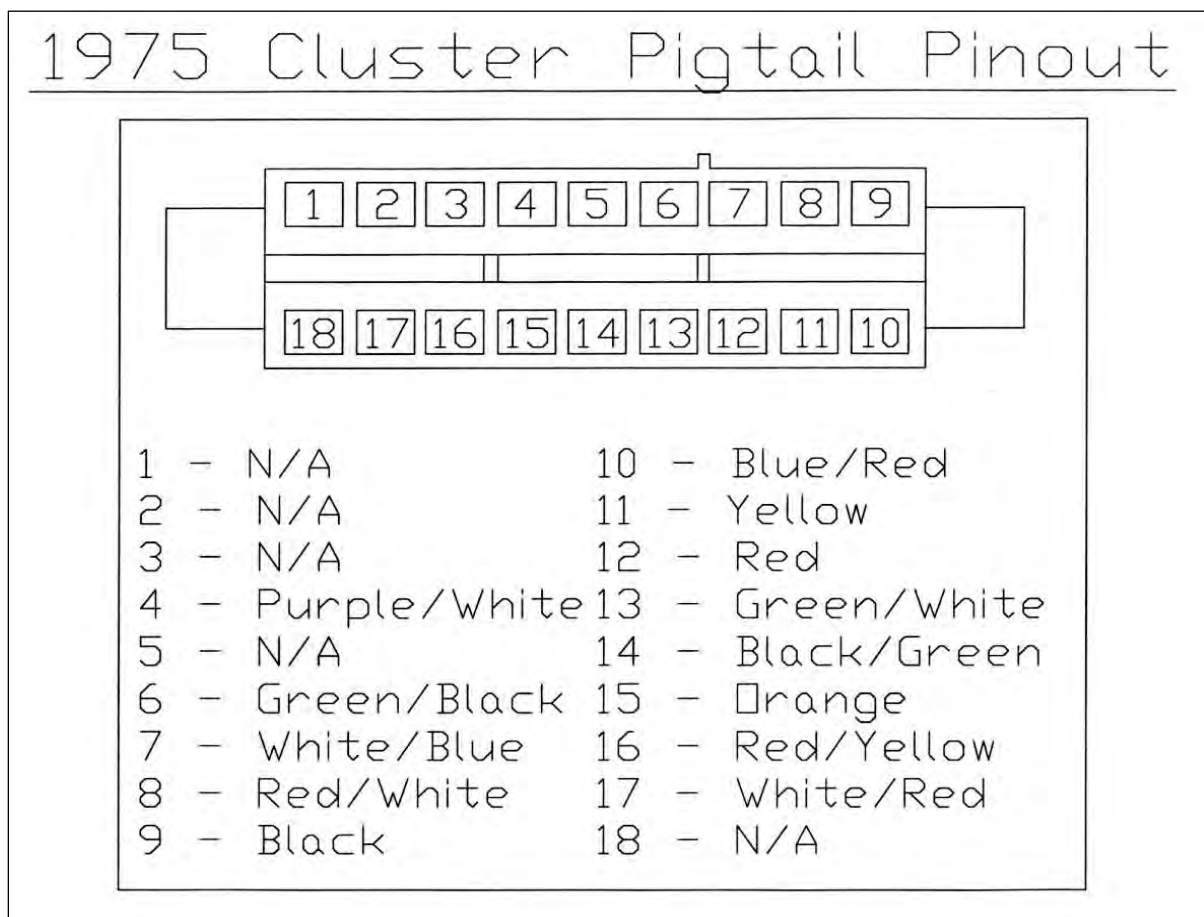

Figure 7-39 1975 Cluster Pigtail Pinout

1976-77 Cluster Pigtail Pinout

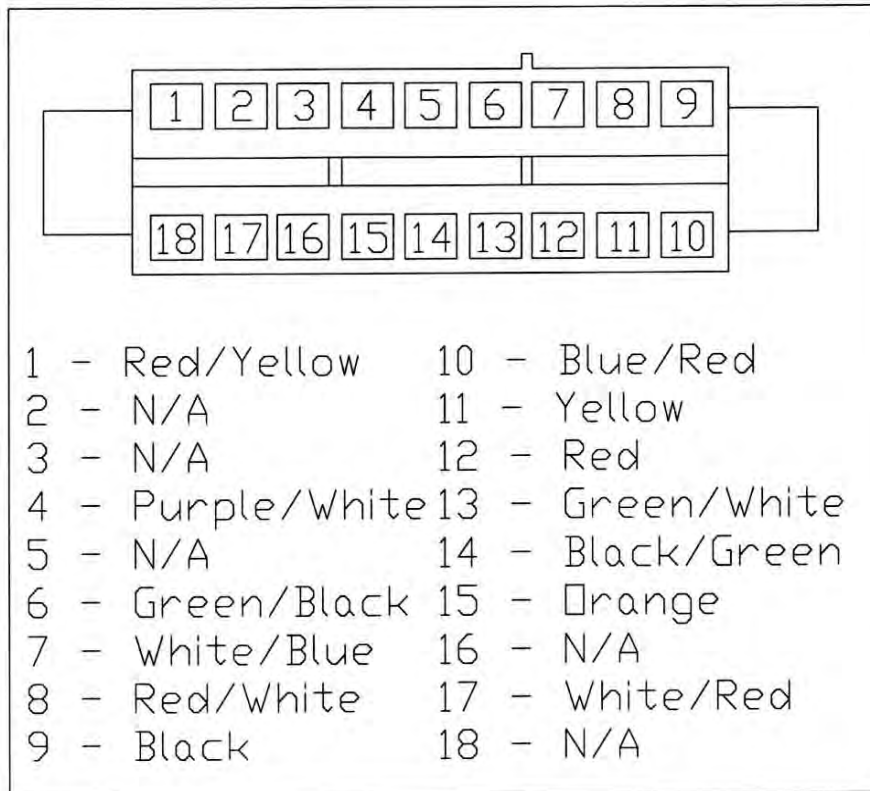

Figure 7-40 1976-77 Cluster Pigtail Pinout

7.19 Ignition Switch Pin Outs – 1967 – 1977 Ford Trucks

7.19.1 When installing Painless Wiring Harness Part Number 10117 1967-1977 Ford Truck harness without switches it will be necessary to use Figures 7-41 thru 7-44. Each Figure corresponds with a specific year(s) of Ford Truck. Locate the year of truck being rewired and connect the new harness Ignition Switch wires to the Ignition Switch as indicated. NOTE: ON 1968-70 Ford Truck Ignition switches it will be necessary to reuse the original connector from the original harness. Butt splice terminals have been provided in the parts kit to reuse a small portion of the original wires in the connector and splice it onto the new harnesses wires.

1967 Ford Truck Ignition Switch

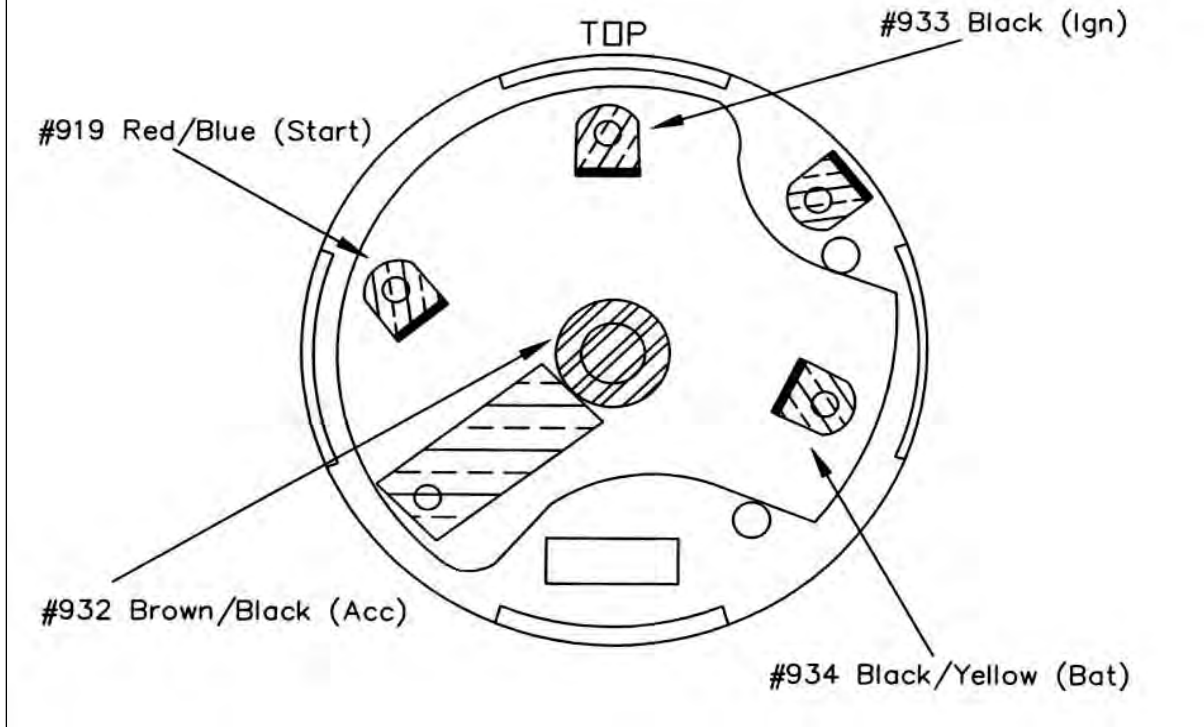

Figure 7-41 1967 Ford Truck Ignition Switch

1968-70 Ford Truck Ignition Switch

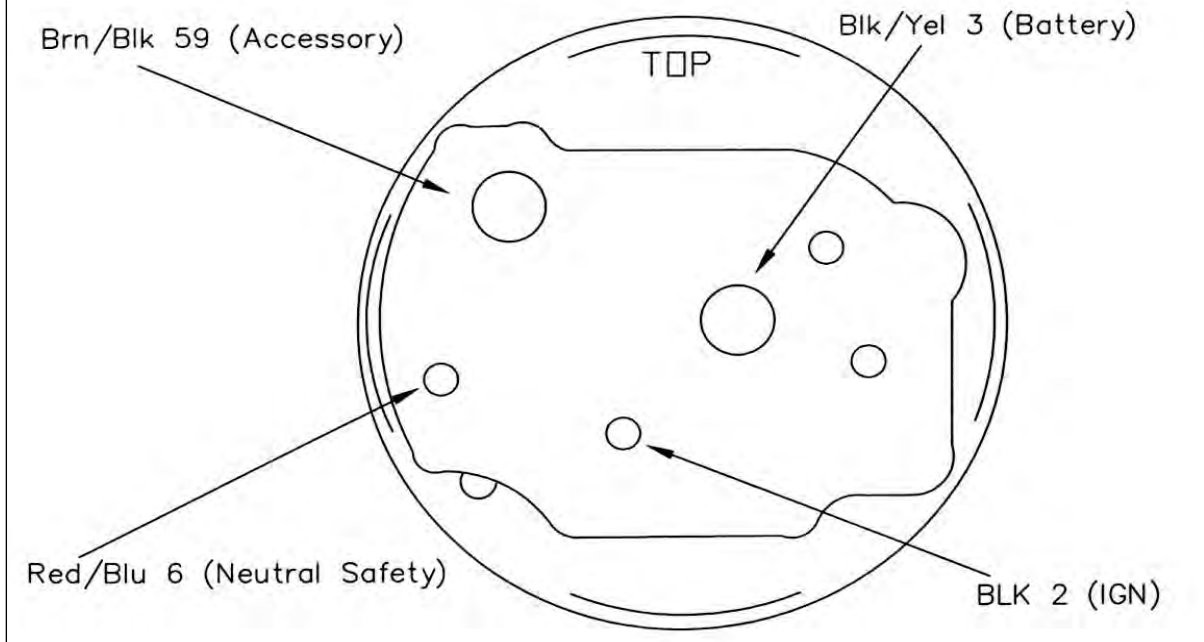

Figure 7-42 1968 - 1970 Ford Truck Ignition Switch

1970-76 Ford Truck Ignition Switch

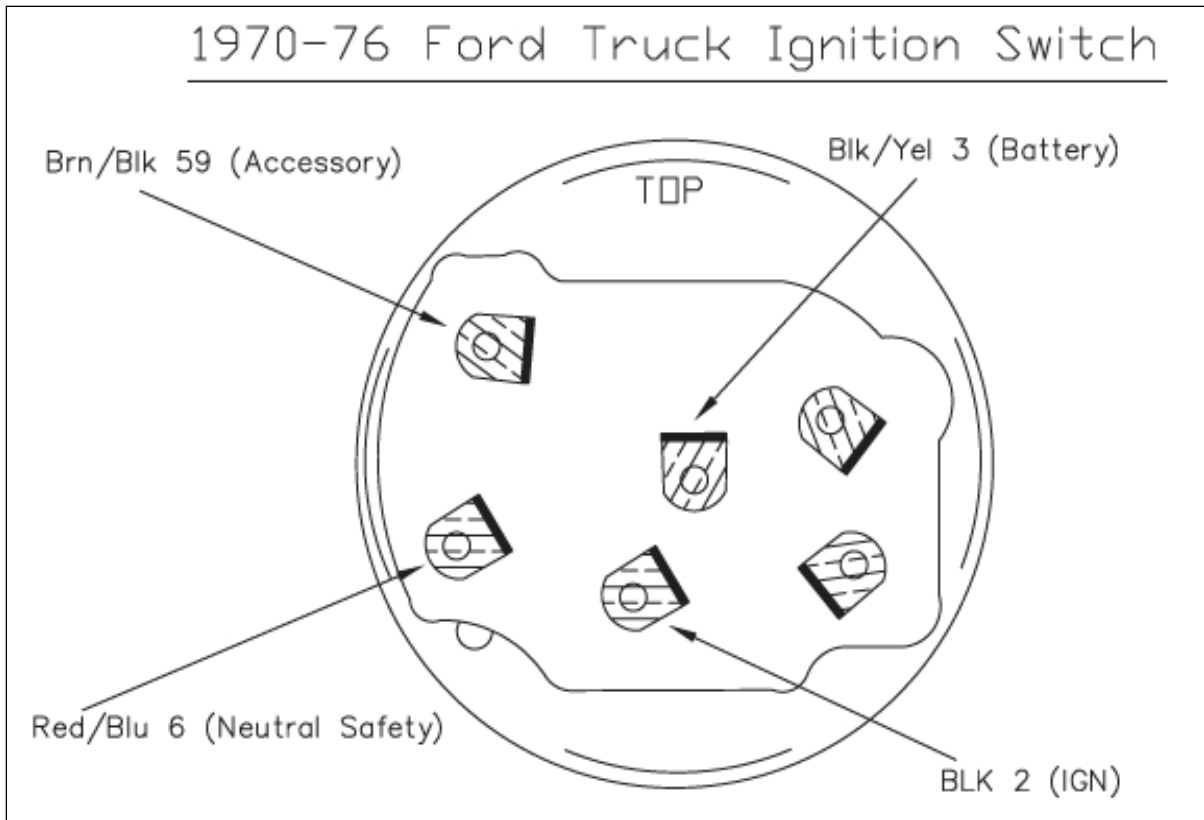

Figure 7-43 1970 – 1976 Ford Truck Ignition Switch

1977 Ford Truck Ignition Switch

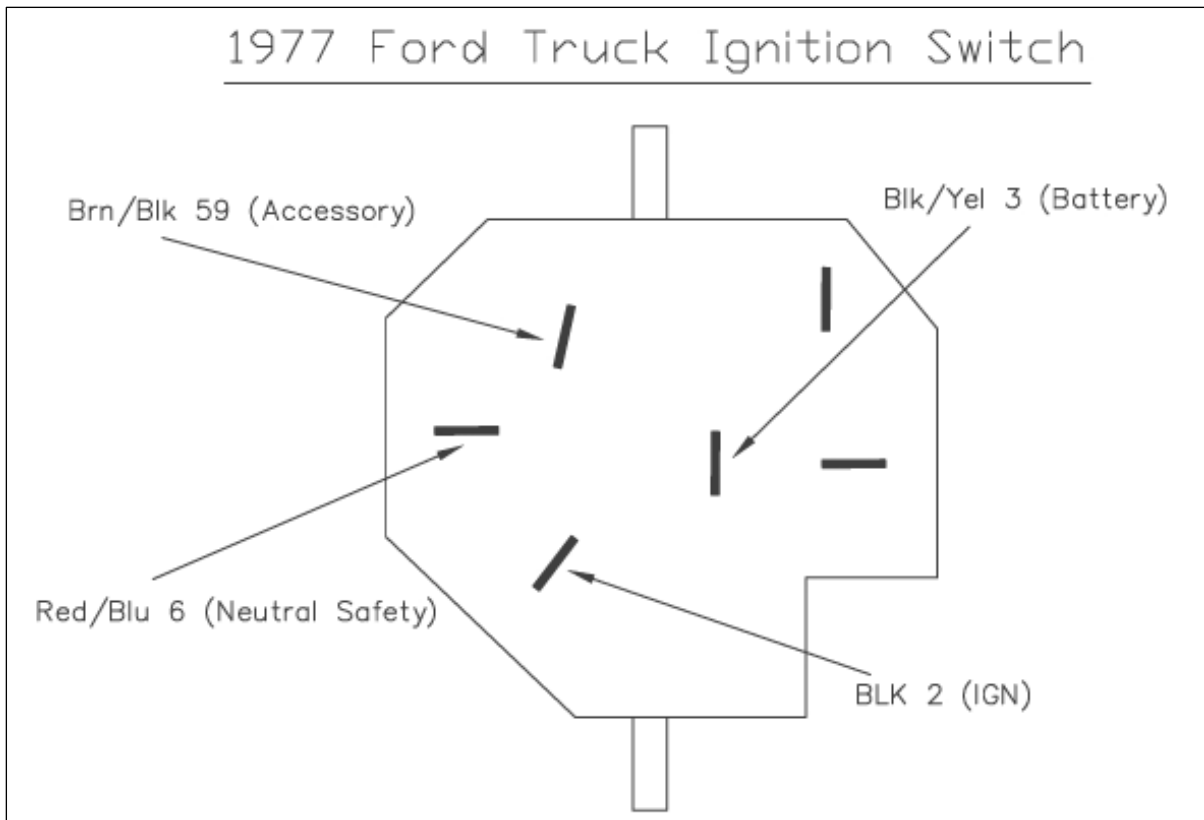

Figure 7-44 1977 Ford Truck Ignition Switch

7.20 Interior Lighting Section – Accessories

- 7.13.1 Constant Radio B+ #940 is to be connected to the Memory or Constant input on an aftermarket stereo. (Most CD players with a clock require this input)
The Switched Radio B+ #941 is another wire required on most stereos.
- 7.13.2 If a Tachometer is to be installed use wire (Tachometer Signal #923) for the signal from the negative side of the ignition coil.
- 7.13.3 Wire (#955 To 4X4 Light or 10AMP Accessory) is for a 10Amp Accessory. This is a fused switched ignition hot wire.
- 7.13.4 The final Accessory component in this Ford Truck chassis harness is a 20amp accessory relay output. The relay is preinstalled in the fuse block, powered, and fused. It ONLY requires a ground to be activated. **See Figure 7-45.**

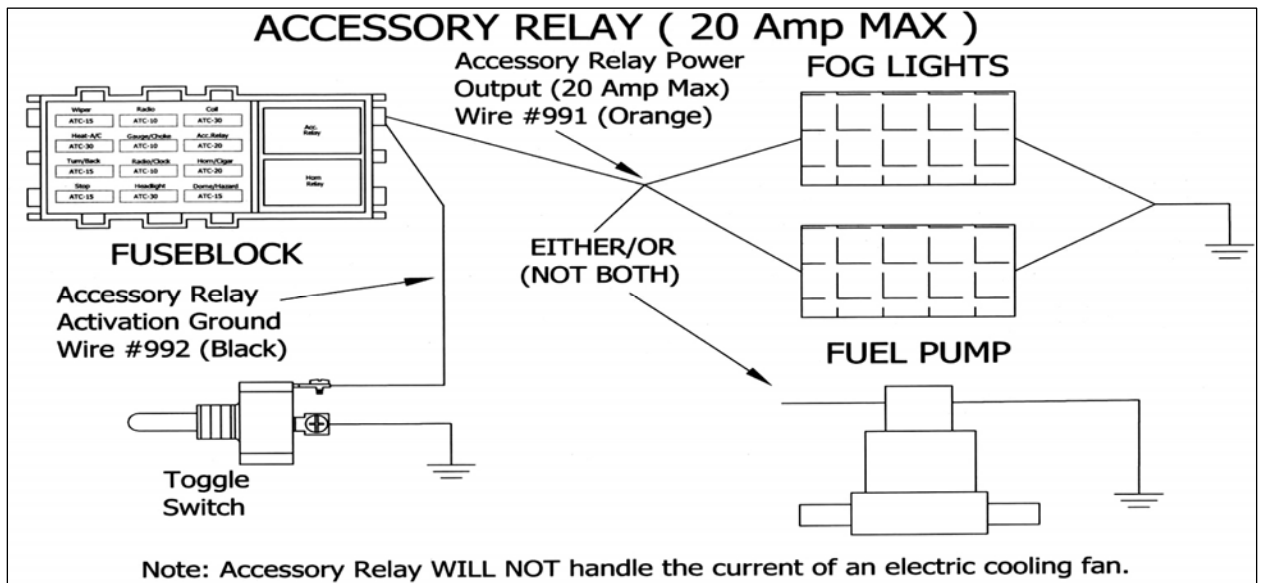

Figure 7-45 Accessory Relay Diagram

8.0 WIRE CONNECTION INDEX AND FUSE REQUIREMENTS

8.1 Wire Connection Index

In each section, connect the wire, as identified by its wire color, to the appropriate item in the Wire Ending Point column.

Table 8.2 is divided into sections that correspond to the sections of your wire harness. (ENGINE SECTION, DRIVERS SIDE SECTION, PASSENGER SIDE SECTION, GAUGE CLUSTER SECTION, UNDER-DASH SECTION, INTERIOR LIGHTING SECTION, AND TAIL SECTION) The index is divided vertically into six columns. COLOR, GAUGE, NUMBER, WIRE PRINT, WIRE STARTING POINT, and WIRE ENDING POINT.

The information in these columns is for reference to help identify where each wire is and what it needs to be connected to. These columns tell where each wire originates, the wire number, its function and which section of the harness the wire is in.

The column labeled NO. contains a 900-series number used to identify the wires in the diagrams in Section 7.0 of this manual.

The wire numbers which occur TWICE in this index indicate the connection of BOTH ENDS or a splice of wires inside the harness. Most wire segments are pre-connected at the WIRE STARTING POINT such as all the wires originating from the fuse panel. The WIRE ENDING POINT is where the wire needs to be connected.

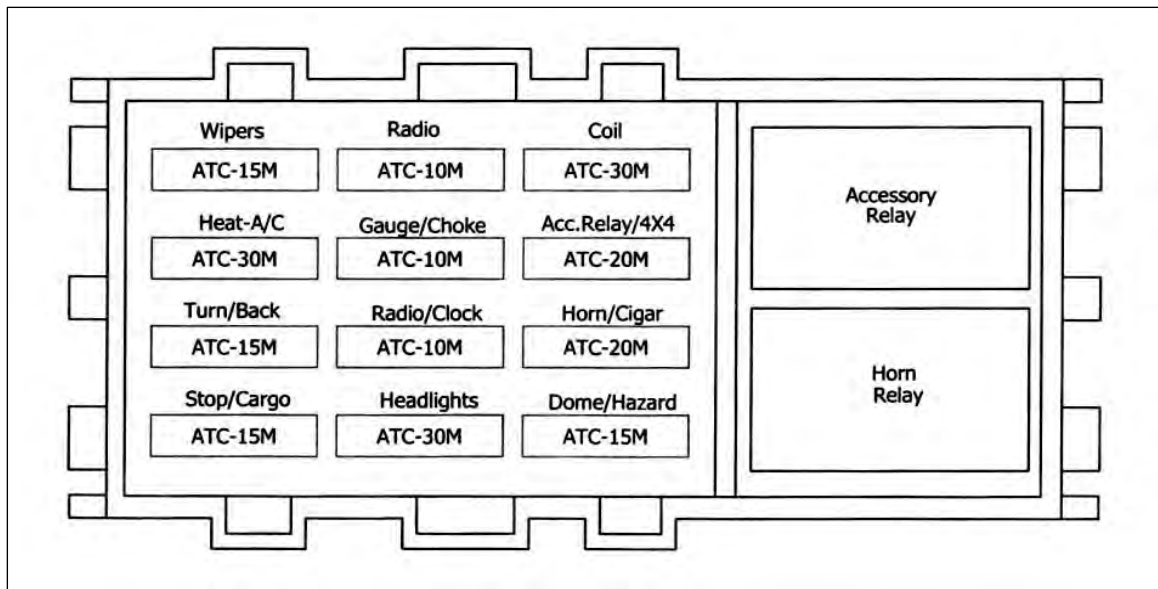

Table 8.1 Fuse Requirements

Color	Gauge	Wire #	Wire Print	Wire Starting Point	Wire Ending Point
Engine Section					
Wht/Blu	18	954	To Electric Choke	Fuse Block	Electric Choke
Red/Grn	14	920	To Coil "+"	Fuse Block	Coil "+"
Red/Wht	18	921	To Temp Sender – To Temp Gauge or Light	Temperature Sender	Temperature Gauge or Light
Wht/Red	18	922	To Oil Sender – To Oil Gauge or Light	Oil Pressure Sender	Oil Pressure Gauge or Light
Brn	16	970	To Ignition Coil "+" – To Starter Solenoid "I"	Coil "+"	Starter Solenoid
Red/Ylw	18	923	To Coil "-" – To Tachometer	Coil "-"	Tachometer
Blk/Wht	14	902	A/C Thermostat to A/C Compressor	A/C Compressor	A/C Thermostat
Passenger Side Section					
Brn	16	970	To Starter Solenoid "I" – To Ignition Coil "+"	Starter Solenoid "I" Post	Coil "+"
Red/Blu	12	919	To Starter Solenoid – To Neutral Safety Switch	Starter Solenoid "S" Post	Neutral Safety Switch
Blk/Ylw	10	916	Battery Source (Maxi Fuse)	Starter Solenoid "B+"	Fuse Block - Power Splice
Grn/Red	18	914	Alternator Regulator Exciter	Voltage Regulator Connector	Charge Light in Gauge Cluster
Blk	10	915	Alternator Output Post	Alternator	Fuse Block - Power Splice
Ylw/Grn	16	924	To Horn	Passenger Side Horn	Horn Relay
Wht/Blu	18	925	To Right Front Turn Signal	Right Front Turn Signal	Turn Signal Switch
Blk/Ylw	18	927	To Front Park Lights	Front Park Lights	Headlight Switch
Grn/Blk	16	908	To Headlight High Beam	High Beam Headlight	Dimmer Switch
Red/Blk	16	909	To Headlight Low Beam	Low Beam Headlight	Dimmer Switch
Ylw	14	995	To Alternator Regulator B+	Voltage Regulator Connector	Fuse Block - Constant Hot

Table 8.2 Wire Connection Index

Color	Gauge	Wire #	Wire Print	Wire Starting Point	Wire Ending Point
Driver Side Section					
Grn/Wht	18	926	To Left Front Turn Signal	Left Front Turn Signal	Turn Signal Switch
Grn/Blk	16	908	To Headlight High Beam	High Beam Headlight	Dimmer Switch
Red/Blk	16	909	To Headlight Low Beam	Low Beam Headlight	Dimmer Switch
Pur/Wht	18	968	To Prop. Valve Switch	Proportioning Valve	Brake Light
Blk/Ylw	18	927	To Front Park Lights	Front Park Lights	Headlight Switch
Red	18	972	Ammeter Loop	With #916 (Maxi Fuse)	Ammeter
Ylw	18	972	Ammeter Loop	With #915 (Alternator Output Post)	Ammeter
Org	16	996	Alternator Regulator – Field	Field Post (Alternator)	Voltage Regulator Connector
Wht/Blk	16	997	Alternator Regulator – Stator	Stator Post (Alternator)	Voltage Regulator Connector
Ylw/Grn	16	924	To Horn	Drivers Side Horn	Horn Relay
LtGrn	18	998	Wiper Washer Motor	Wiper Washer Motor	Wiper Switch-Washer Output
Gauge Cluster Section					
Blk	18		Connector Pin (1)	Chassis Ground	Dash Ground
Grn/Red	18		Connector Pin (2)	Charge Indicator Light	Voltage Regulator-Excite Signal
Grn/Wht	18		Connector Pin (3)	Left Turn Indicator	Turn Signal Switch
Wht/Blu	18		Connector Pin (4)	Right Turn Indicator	Turn Signal Switch
Org	18		Connector Pin (5)	Fuel Gauge	Fuel Sending Unit
Grn/Blk	18		Connector Pin (6)	High Beam Indicator	Dimmer Switch
Blk/Grn	18		Connector Pin (7)	Constant Voltage 12V	Fuse Block

Table 8.2 Wire Connection Index

Color	Gauge	Wire #	Wire Print	Wire Starting Point	Wire Ending Point
Gauge Cluster Section Con't					
Red/Wht	18		Connector Pin (8)	Temperature Light or Gauge	Temperature Sending Unit
Wht/Red	18		Connector Pin (9)	Oil Pressure Light or Gauge	Oil Pressure Sending Unit
Ylw	18		Connector Pin (10)	With #915 (Alternator Output Post)	Ammeter
Blu/Red	18		Connector Pin (11)	Gauge Cluster Illumination	Headlight Switch "I"
Red	18		Connector Pin (12)	With #916 (Maxi Fuse)	Ammeter
Under Dash Section (Switches)					
Headlight Switch					
Blk/Org	12	928	To Headlight Switch Power B+	"B" Terminal	Fuse Block
Blk/Blu	18	945	Dome Switch B+1(D1) Headlight Switch	"D1" Terminal	Fuse Block
Grn/Ylw	18	971	Dome Light Power(D2) Headlight Switch	"D2" Terminal	Dome Light
Red/Ylw	14	907	To Dimmer Switch – To Headlight Switch	"H" Terminal	Dimmer Switch
Blu/Red	18	930	Instrument Panel Lighting	"I" Terminal	Gauge Cluster Illumination
Brn	16	929	To Rear Tail Lights	"R" Terminal	Tail Lights
Blk/Ylw	18	927	To Front Park Lights	"P" Terminal	Front Park Lights
Ignition Switch					
Blk/Ylw	12	934	To Ignition Switch Power B+	Refer to Correct Year/Design	Fuse Block
Blk	12	933	To Ignition Switch "IGN"	Refer to Correct Year/Design	Fuse Block
Brn/Blk	12	932	To Ignition Switch Accessory	Refer to Correct Year/Design	Fuse Block
Red/Blu	12	919	To Ignition Switch – To Neutral Safety Switch	Refer to Correct Year/Design	Neutral Safety Switch

Table 8.2 Wire Connection Index

Color	Gauge	Wire #	Wire Print	Wire Starting Point	Wire Ending Point
Under Dash Section (Switches Con't)					
Wiper Switch					
See Figure 7-20					
Brake Switch					
Red/Blk	16	918	To Brake Switch	Brake Switch	Turn Switch
Red	14	917	To Brake Switch Power B+	Brake Switch	Fuse Block
Dimmer Switch					
Red/Blk	14	909	Dimmer Switch-Low Beams	Dimmer Switch	Low Beam Headlights
Grn/Blk	14	908	Dimmer Switch-High Beams	Dimmer Switch	High Beam Headlights
Red/Ylw	14	907	To Dimmer Switch – To Headlight Switch	Dimmer Switch	Headlight Switch
Neutral Safety/Backup Light Switch					
Red/Blu	12	919	To Ignition Switch – To Neutral Safety Switch	Neutral Safety Switch	Ignition Switch
Red/Blu	12	919	To Neutral Safety Switch – To Starter Solenoid	Neutral Safety Switch	"S" Term on Starter Solenoid
Blk/Red	18	958	Back-up Light Switch B+	Backup Light Switch	Fuse Block
Blk/Red	18	956	Backup Lights	Backup Light Switch	Backup Lights
Under Dash Section					
Blu/Wht	14	903	To Cigar Lighter B+	Cigar Lighter	Fuse Block
Red/Ylw	18	923	To Coil (-) – To Tachometer	Tachometer	Coil (-)
Org/Blk	18	955	To 4X4 Light or 10Amp Accessory	Accessory	Fuse Block
Red/Wht	18	941	Radio Power (Switched)	Switched Power Input to Radio	Fuse Block
Red	18	940	Radio Power (Constant)	Constant Power Input to Radio	Fuse Block
Org	16	991	Accessory Relay Output	Accessory Relay	20 Amp Accessory
Blk	18	992	Accessory Relay Activation Ground	Accessory Relay	Grounding Switch
LtGrn/Ylw	18	993	Cargo Lamp Switch Power	Cargo Lamp Switch	Fuse Block

Table 8.2 Wire Connection Index

Color	Gauge	Wire #	Wire Print	Wire Starting Point	Wire Ending Point
Under Dash Section Con't					
LtGrn/Ylw	18	994	Cargo Lamp	Cargo Lamp	Cargo Lamp Switch
Red/Blk	16	918	To Hazard Switch – Not On Column – Brake Input	Glove Box Hazard Switch	Brake Switch
Wht/Red	16	951	To Hazard Switch – Not On Column – Hazard Input	Glove Box Hazard Switch	Hazard Flasher
Grn/Wht	18	926	To Hazard Switch – Not On Column – Left Front Turn	Glove Box Hazard Switch	Left Front Turn Signal
Wht/Blu	18	925	To Hazard Switch – Not On Column – Right Front Turn	Glove Box Hazard Switch	Right Front Turn Signal
Blk/Wht	14	902	A/C Thermostat To A/C Compressor	A/C Thermostat	A/C Compressor
Org	12	904	To A/C-Heat Power B+	A/C-Heat Power Input	Fuse Block
Tail Section					
Brn	16	929	To Tail Lights	Left and Right Tail Lights	Headlight Switch
Org	18	939	To Fuel Sender – To Fuel Gauge	Fuel Sender	Fuel Gauge
Grn	16	948	To Right Turn/Brake	Right Turn/Brake	Turn Signal Switch
Ylw	16	949	To Left Turn/Brake	Left Turn/Brake	Turn Signal Switch
Blk/Red	18	956	Backup Lights	Backup Lights	Backup Light Switch
Brn/Wht	18	962	License Plate Light	License Plate Light	Headlight Switch

Table 8.2 Wire Connection Index

Painless Performance Limited Warranty and Return Policy

Chassis harnesses and fuel injection harnesses are covered under a lifetime warranty.

All other products manufactured and/or sold by Painless Performance are warranted to the original purchaser to be free from defects in material and workmanship under normal use. Painless Performance will repair or replace defective products without charge during the first 12 months from the purchase date. No products will be considered for warranty without a copy of the purchase receipt showing the sellers name, address and date of purchase. You must return the product to the dealer you purchased it from to initiate warranty procedures.