

The 400mph Company™

Intake Installation Instructions

P/N 9910 (red filter) - P/N 9910B (blue filter)

P/N 9910K (black filter) - P/N 9910W (white filter)

Year/Make/Model/Engine

2007-2009 CHEVROLET CHEYENNE 5.3L
2007-2008 GMC YUKON XL 1500 5.3L, 6.0L, 6.2L
2007-2008 GMC YUKON DENALI 6.2L
2007-2008 GMC YUKON DENALI XL 6.2L
2007-2008 GMC YUKON 4.8L, 5.3L
2007-2008 GMC SIERRA DENALI 6.2L
2007-2008 GMC SIERRA 1500 4.8L, 5.3L, 6.0L
2007-2008 CHEVROLET TAHOE 4.8L, 5.3L
2007-2008 CHEVROLET SUBURBAN 1500 5.3L, 6.0L
2007-2008 CHEVROLET SILVERADO 1500 4.8L, 5.3L, 6.0L
2007-2008 CHEVROLET AVALANCHE 5.3L, 6.0L
2007-2008 CADILLAC ESCALADE 6.2L

NOT LEGAL FOR SALE OR USE ON ANY POLLUTION CONTROLLED MOTOR VEHICLE IN CALIFORNIA OR STATES ADOPTING CALIFORNIA EMISSION PROCEDURES.

See Spectreperformance.com for CARB status on each part for a specific vehicle

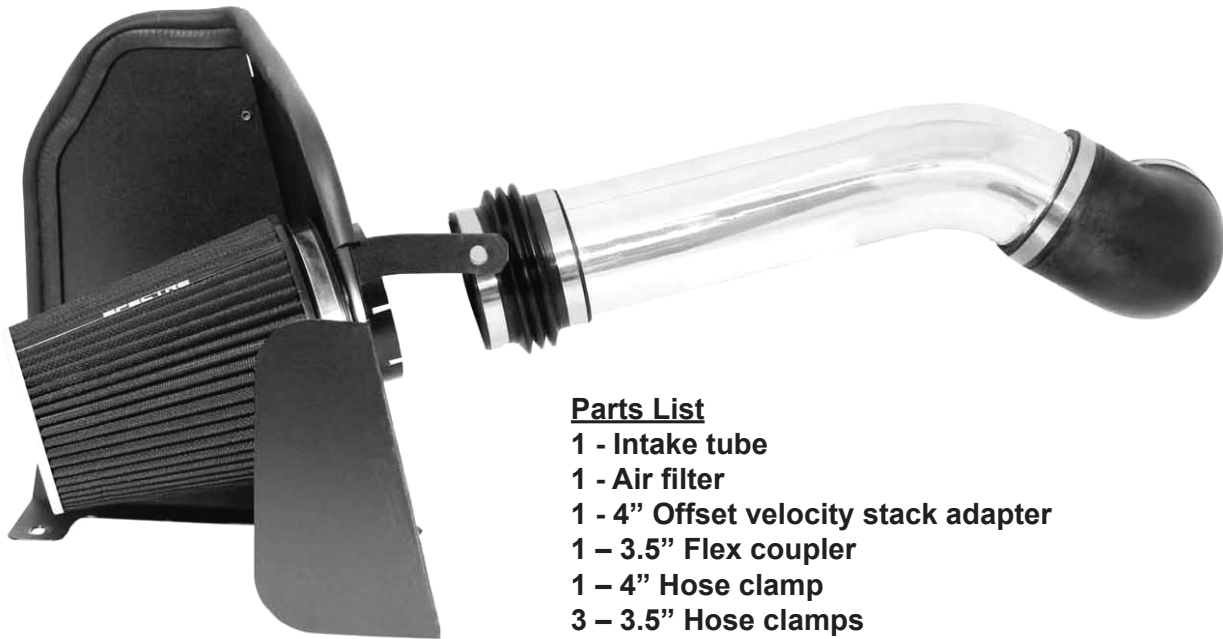

Parts List

- 1 - Intake tube
- 1 - Air filter
- 1 - 4" Offset velocity stack adapter
- 1 - 3.5" Flex coupler
- 1 - 4" Hose clamp
- 3 - 3.5" Hose clamps
- 1 - 6" Hose clamp
- 1 - 90° Rubber elbow
- 2- Bolts, hex/flange
- 2- Lock washers
- 3- Allen bolts
- 3- Flat washers
- 3- Locknuts
- 1- Allen wrench
- 1 - Heat shield Pc 1
- 1 - Heat shield Pc 2
- 1- Rubber seal
- 1- 3/8" Breather hose

Tools Required:

- 5/16" or 8mm nut driver
- Ratchet
- 10mm socket
- 13mm socket

For filter reorders ask at the special order counter of your local parts store or call:

1-909-673-9800

ask for: P/N HPR9891 (red filter)

P/N HPR9891B (blue filter)

P/N HPR9891K (black filter)

P/N HPR9891W (white filter)



Step 1

Safety first! Before you begin the installation, make sure that the vehicle is in park (or neutral for a manual transmission) with the parking brake set. Disconnect the negative battery terminal and verify that all components that are listed are present. Note: This kit was designed and tested on a stock engine without any custom tuning done to the engine computer. Removing the battery cable may erase the programmed radio stations. The anti-theft code will need to be entered into some radios after the battery cable is connected. The anti-theft code can typically be found in the owner's manual or at your local dealership.



Step 2

Start by removing the engine cover that is attached by small ball and socket joints or fastened with hardware. Lift the cover up and off and it will come off easily. Depending on the year, make, and model the cover may vary.

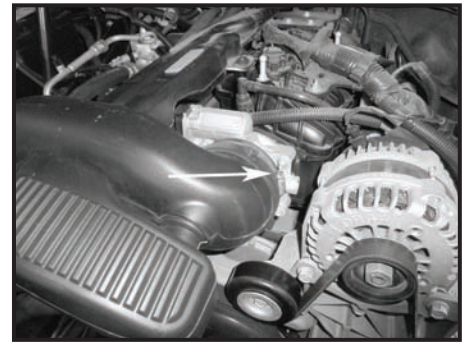

Step 3

Loosen the clamp at the throttle body.

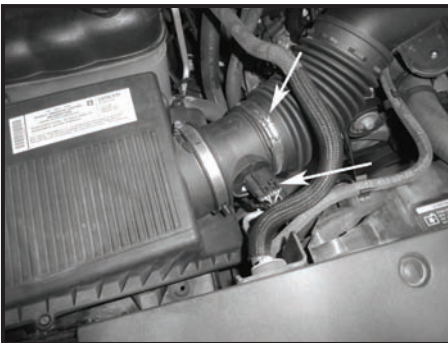

Step 4

Loosen the clamp at the Mass Air Flow Sensor (MAFS). Disconnect the MAFS electrical connector.

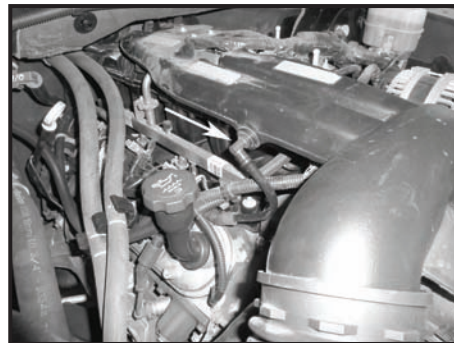

Step 5

Pull firmly and disconnect the breather hose from the stock intake resonator. Remove the factory intake tube.

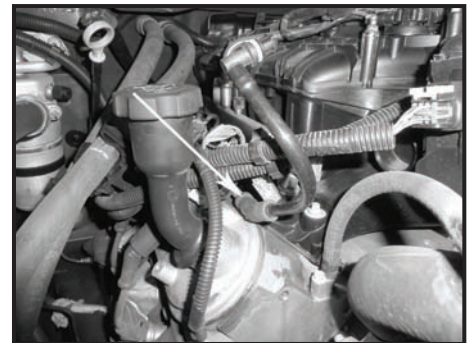

Step 6

Remove the breather tube from the engine by pulling the rubber end firmly from the engine.

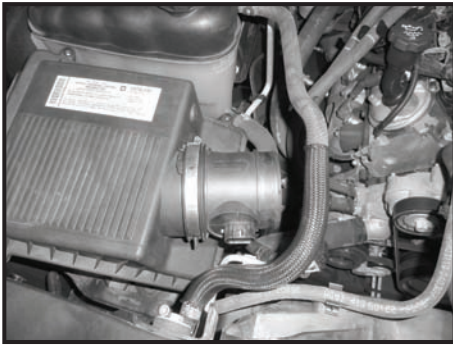

Step 7
Remove the air box assembly by pulling up and out firmly.

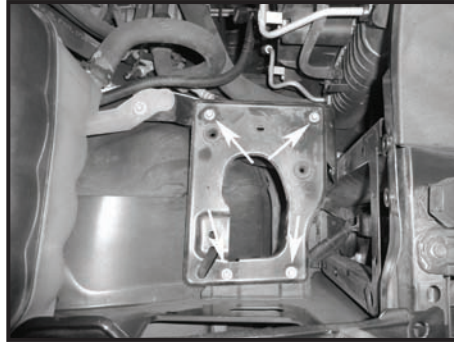

Step 8
Remove the air box mounting plate. Two of these bolts will be re installed with the new heat shield.



Step 9
Remove the MAFS from the factory air box making sure the factory boot stays on the MAFS.

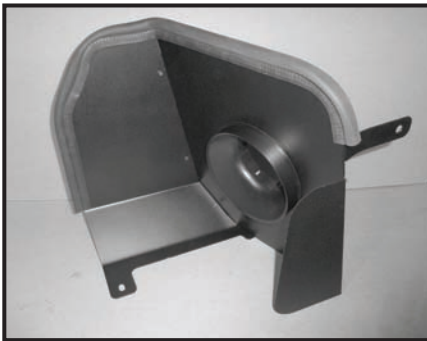

Step 10
Assemble the heat shield with the tabs placed on the outside of heat shield. Install bulb seal around edges of heat shield as shown. Place the velocity stack adaptor in the heat shield and install the supplied coupler making sure the coupler is pushed completely against the heat shield. Once the adapter and coupler are tight against the heat shield, tighten the clamp.

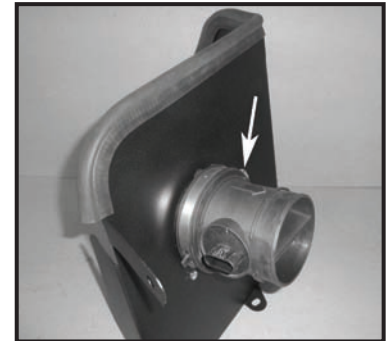

Step 11
Install the MAFS on the end of the velocity stack adaptor. Take note of the orientation of the MAFS and once in the desired location fasten it securely.



Step 12
Remove the bolt from the radiator shroud. This will be reused in Step 14.

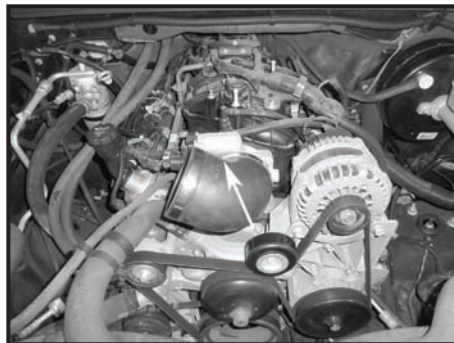

Step 13
Install the 90° boot on throttle body with the short side on the throttle body and clamp on the throttle body side to secure the boot in place. Install a second clamp but do not tighten at this time.

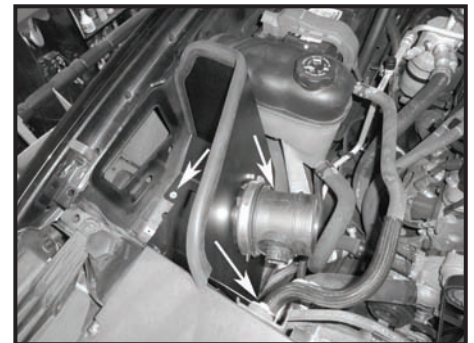

Step 14
Install the heat shield into the truck as shown by reusing the hardware from the tray. There are two bolts that will go in the bottom. The third bolt will be reused from the radiator mount removed in Step 12.

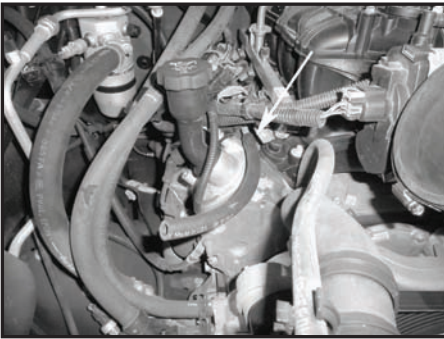

Step 15
Connect the supplied hose to the breather tube on the motor.

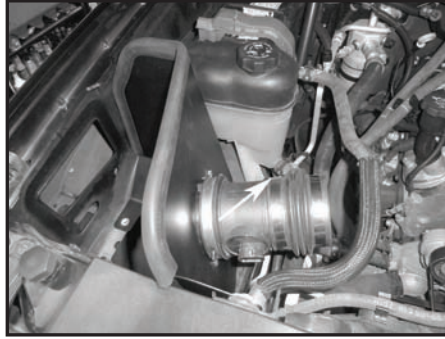

Step 16
Install the flex coupler on the end of the MAFS and secure the boot in place. Install a second clamp but do not tighten at this time.

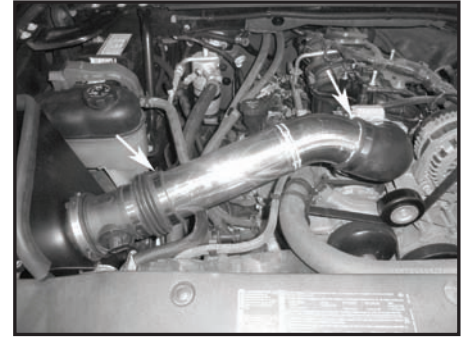

Step 17
Install the intake tube as shown and once in position tighten clamps.

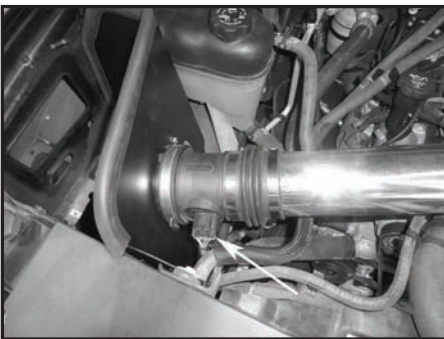

Step 18
Reconnect the MAFS wiring harness.

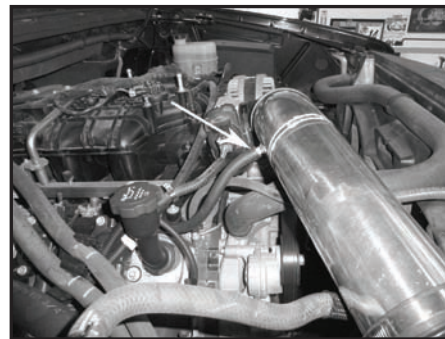

Step 19
Install the new hose onto the vacuum fitting on the intake tube.

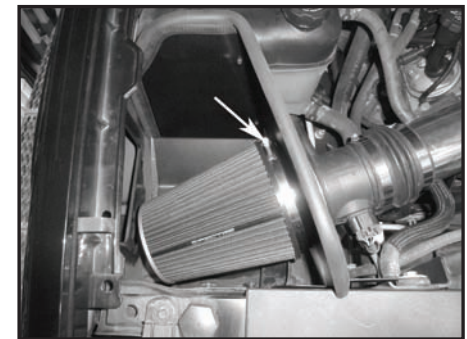

Step 20
Install the filter and fully tighten the clamp.



Step 21
Reinstall the engine cover. Make sure that all clamps and hardware are fully tightened. Reconnect the battery cable, start the vehicle and let it warm up. Shut off and inspect the installation once more for any loose clamps, wires, or hardware. Test drive & enjoy! Your installation is now complete. Periodically check all clamps and brackets.

If you have any difficulties or questions regarding the installation of this intake system, contact the Spectre Performance Technical Department by email - Tech@spectreperformance.com or by phone 1-909-673-9800 Monday thru Friday 6:00am to 2:00pm PST.

NOT LEGAL FOR SALE OR USE ON ANY POLLUTION CONTROLLED MOTOR VEHICLE IN CALIFORNIA OR STATES ADOPTING CALIFORNIA EMISSION PROCEDURES.

See Spectreperformance.com for CARB status on each part for a specific vehicle

SPEED BY SPECTRE

The 400mph Company

(909) 673-9800

www.SpeedBySpectre.com

© 2015 SPECTRE PERFORMANCE Made in China

176149B
4/13/15